

ITEM NUMBER 17101

MARKINGS : REFER PAGE NUMBER 75.

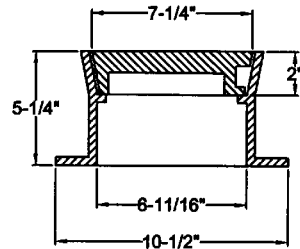
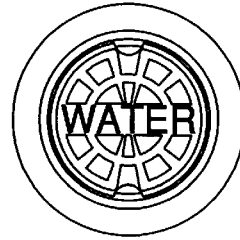

ITEM NUMBER 17051

MARKINGS : WATER & SEWER.

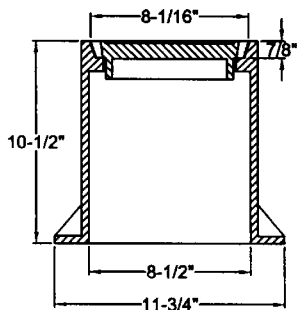
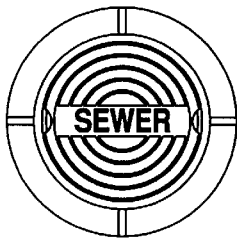

ITEM NUMBER 18111

MARKINGS : SEWER , WATER , CLEANOUT & NONE.

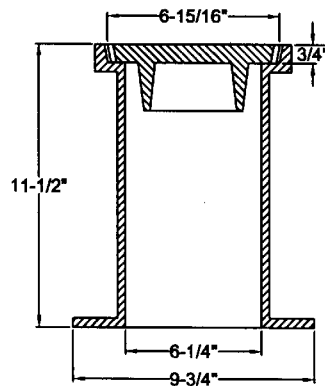
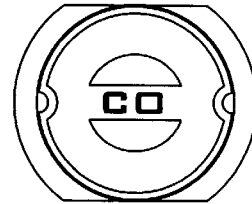

ITEM NUMBER 10711

**LIGHT DUTY CLEANOUT FRAMES & COVERS**

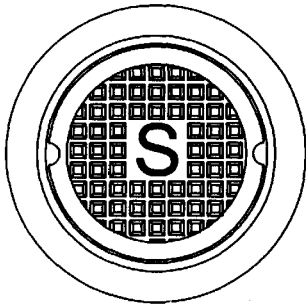

MARKINGS : W & S

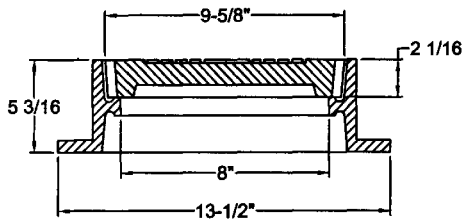

ITEM NUMBER 11041

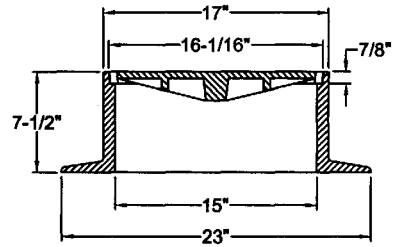
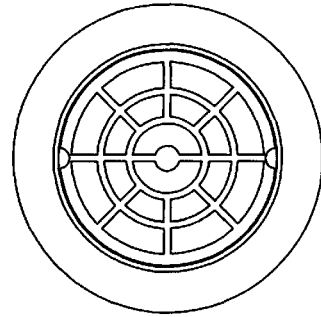

ITEM NUMBER 11671

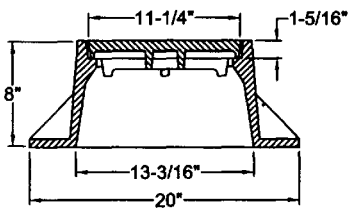
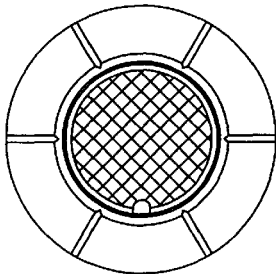

ITEM NUMBER 11181

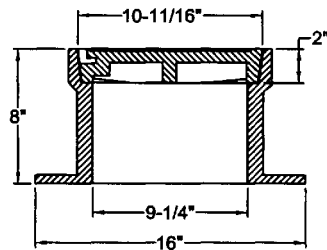
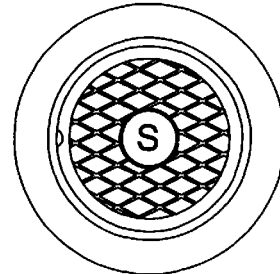

ITEM NUMBER 11081

**HEAVY DUTY CLEANOUT FRAMES & COVERS**

SUITABLE FOR A.A.S.H.T.O. H 20-44 AND HS 20-44 HIGHWAY LOADING.