

FRAME SHOWN WITH TYPE B GRATE

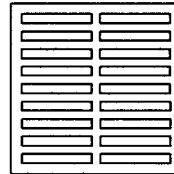

TYPE A GRATE



TYPE B GRATE

ITEM NUMBER	DIMENSIONS IN INCHES						GRATE TYPE
	B	C	D	E	F	X	
21231*	15-1/4	12	10-1/4	3	12-1/4	1	A
21831*	23	18	17	3	18-3/8	1	B
23031	34	30	28	2-1/2	28	1-1/2	B

\*REVERSIBLE TYPE FRAMES.

**LIGHT DUTY SQUARE FRAMES & GRATES**

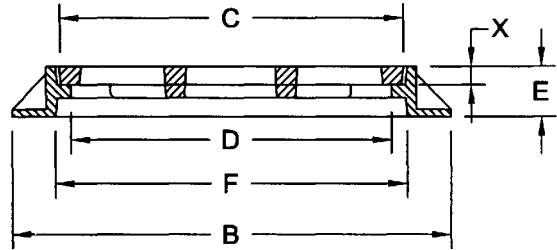
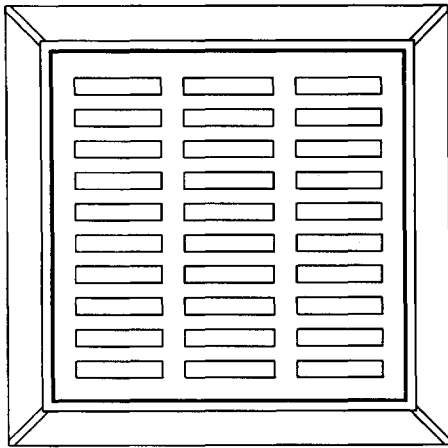

FRAME SHOWN WITH TYPE 'C' GRATE

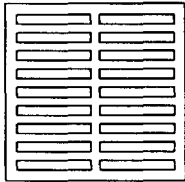

TYPE B GRATE

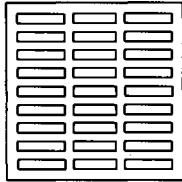

TYPE C GRATE

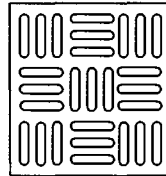

TYPE D GRATE

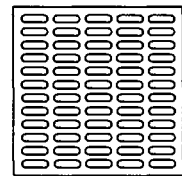

TYPE E GRATE

ITEM NUMBER	DIMENSIONS IN INCHES						GRATE TYPE
	B	C	D	E	F	X	
21833*	23	18	17	3	18-3/8	1	C
21834*	23	18	17	3	18-3/8	1	D
22431*	29-5/8	23-1/2	21-5/8	3-3/8	23-3/4	1-1/4	C
22451	32-5/8	23-1/2	21-1/2	5	23-1/2	1-3/8	B
22531	32	26	24-3/4	3	24-3/4	1-1/2	E
23033	34	30	28	2-1/2	28	1-1/2	C
23241*	38	32	30-1/8	4	32-1/4	1-1/2	E

\*REVERSIBLE TYPE FRAMES.

## HEAVY DUTY SQUARE FRAMES & GRATES

SUITABLE FOR A.A.S.H.T.O. H 20-44 AND HS 20-44 HIGHWAY LOADING.

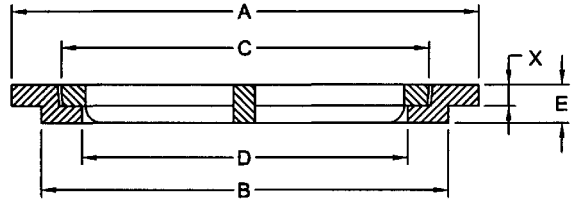
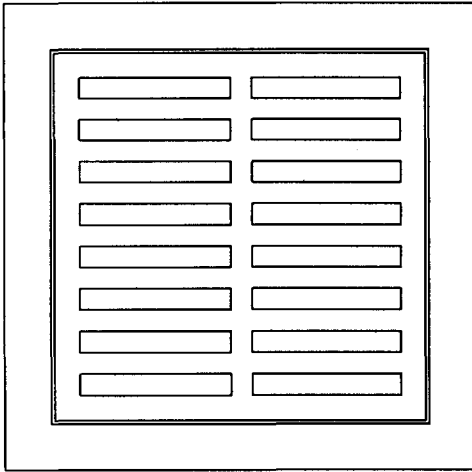

ITEM NUMBER	DIMENSIONS IN INCHES					
	A	B	C	D	E	X
22631	32-1/2	28-3/4	26	23-1/2	2-1/2	1-1/8
22632	33	29-1/4	26	23	2-3/4	1-3/8

**HEAVY DUTY SQUARE FRAMES & GRATES**

**SLAB TYPE FRAMES**

SUITABLE FOR A.A.S.H.T.O. H 20-44 AND HS 20-44 HIGHWAY LOADING.

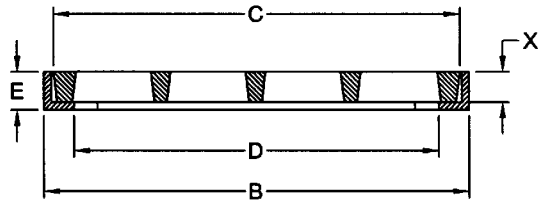
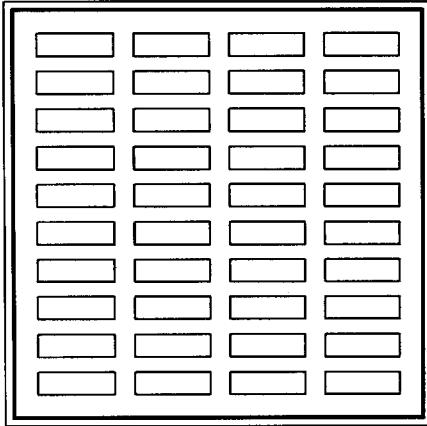

ITEM NUMBER	DIMENSIONS IN INCHES				
	B	C	D	E	X
22415	25-3/4	24	22-1/4	2-1/4	1-1/2
22720	28-1/2	27	25	2-1/2	2
22715	29	27-3/8	25-1/2	1-9/16	1
22700	N/A*	27-3/8	N/A*	N/A*	1

NOTE: \*GRATE ONLY.

## HEAVY DUTY ANGLE FRAMES & GRATES

SUITABLE FOR A.A.S.H.T.O. H 20-44 AND HS 20-44 HIGHWAY LOADING.

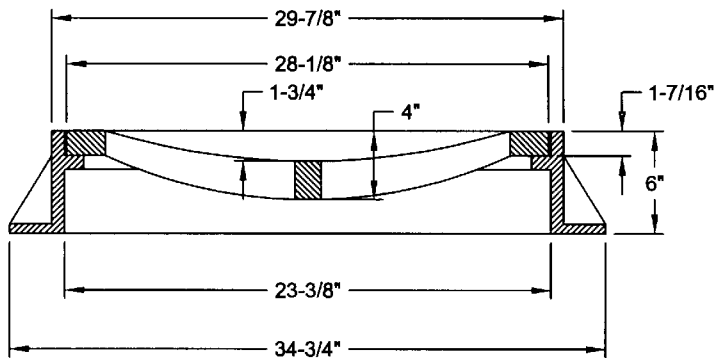
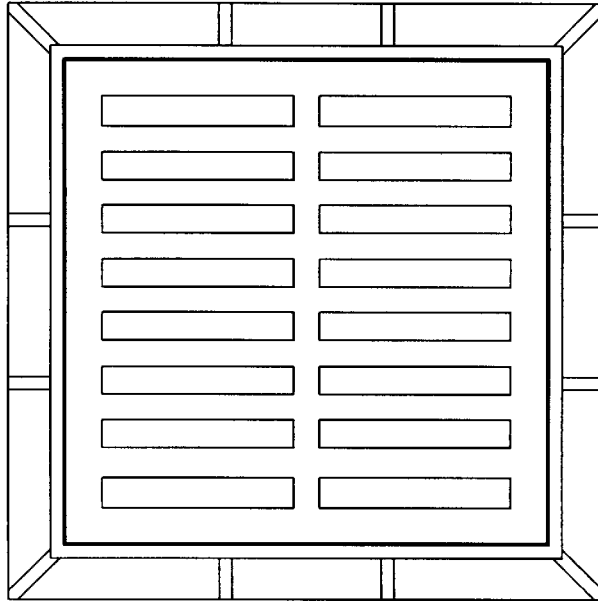

**HEAVY DUTY SQUARE FRAME & CONCAVE GRATE**

ITEM NUMBER 22862

SUITABLE FOR A.A.S.H.T.O. H 20-44 AND HS 20-44 HIGHWAY LOADING.

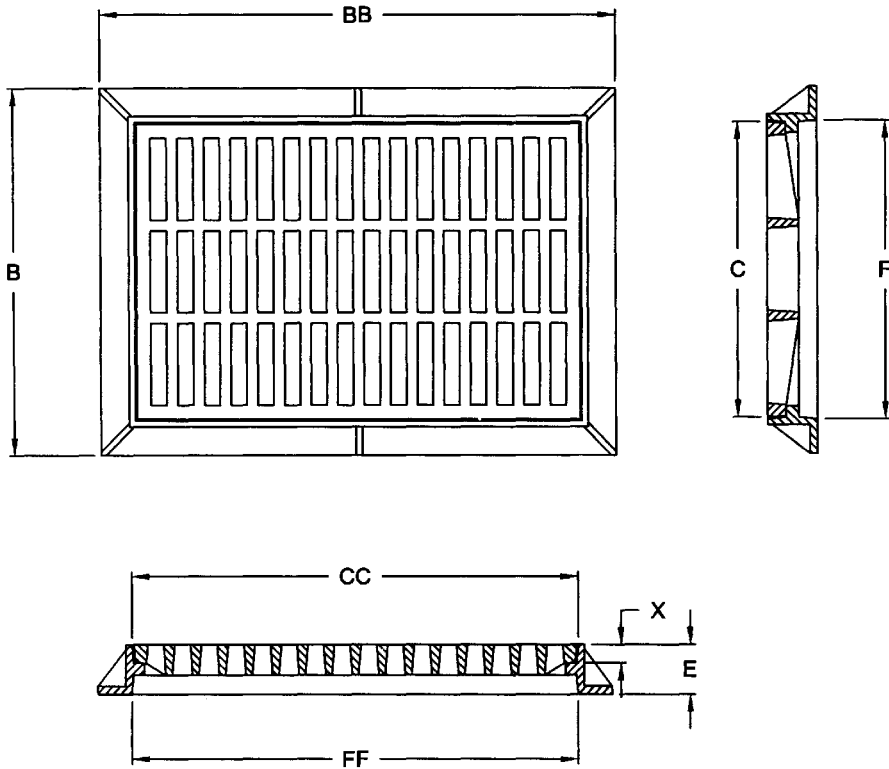

ITEM NUMBER	DIMENSIONS IN INCHES							
	B	BB	C	CC	E	F	FF	X
24363	30	42	23-3/4	35-3/4	2-1/2	22	34	1-1/2
24364*	29-1/2	41-1/2	23-3/4	35-3/4	4	24	36	1-1/2
24367	32	44	23-3/4	35-3/4	7	24	36	1-1/2

\*REVERSIBLE TYPE FRAME.

**HEAVY DUTY RECTANGULAR FRAMES & GRATES**

SUITABLE FOR A.A.S.H.T.O. H 20-44 AND HS 20-44 HIGHWAY LOADING.

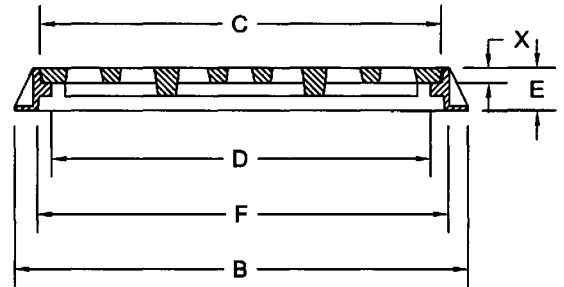
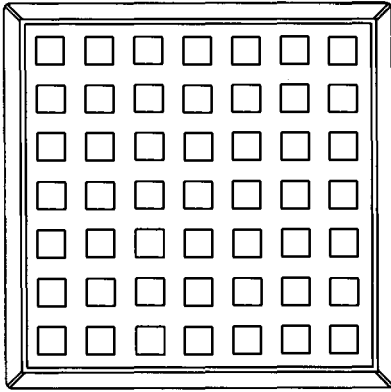

ITEM NUMBER	DIMENSIONS IN INCHES					
	B	C	D	E	F	X
22432*	29-5/8	23-1/2	21-5/8	3-3/8	23-3/4	1-1/4
22532	30	25-1/4	24	2-1/2	24	1-1/2
23032	34	30	28	2-1/2	28	1-1/2
23042*	34	30	28	4	28	1-1/2
23842*	42-3/4	37-7/8	35-3/4	4	38-1/8	1-3/8

\*REVERSIBLE TYPE FRAME.

**HEAVY DUTY FRAMES & SQUARE HOLE GRATES**

SUITABLE FOR A.A.S.H.T.O. H 20-44 AND HS 20-44 HIGHWAY LOADING.

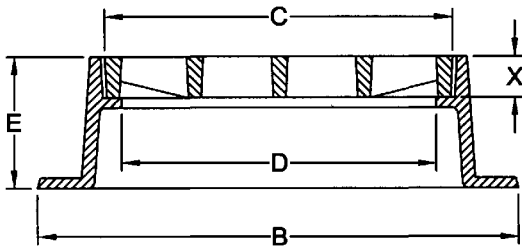
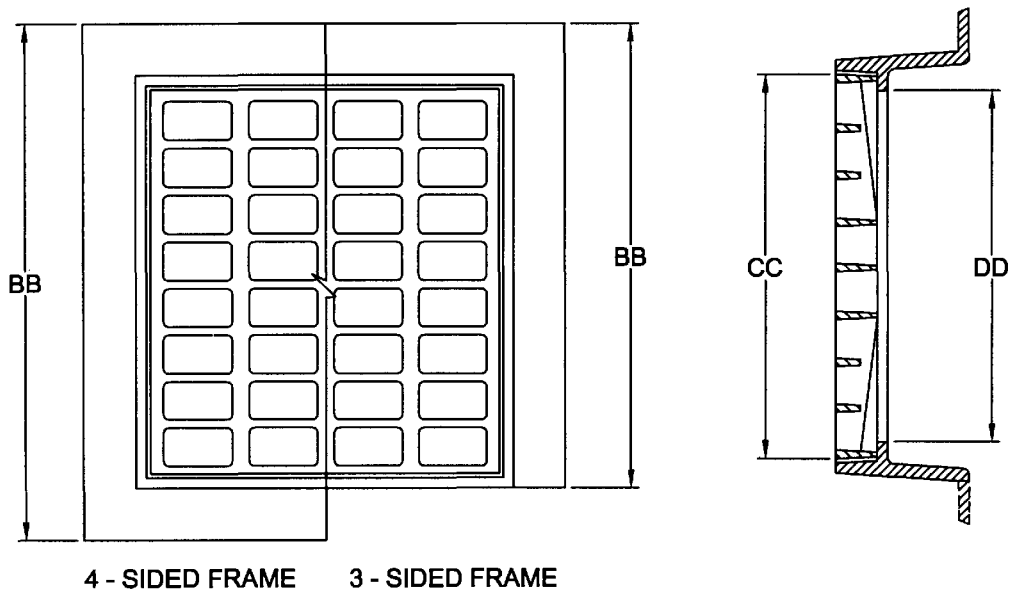

ITEM NUMBER	DIMENSIONS IN INCHES								TYPE OF FRAME
	B	BB	C	CC	D	DD	E	X	
22143	29	28-3/16	21	23-3/16	19	21-3/16	4	2-1/2	3-SIDED
22144	29	31-3/16	21	23-3/16	19	21-3/16	4	2-1/2	4-SIDED
22183	29	28-3/16	21	23-3/16	19	21-3/16	8	2-1/2	3-SIDED
22184	29	31-3/16	21	23-3/16	19	21-3/16	8	2-1/2	4-SIDED

**HEAVY DUTY CB RECTANGULAR FRAMES & GRATES**

SUITABLE FOR A.A.S.H.T.O. H 20-44 AND HS 20-44 HIGHWAY LOADING.



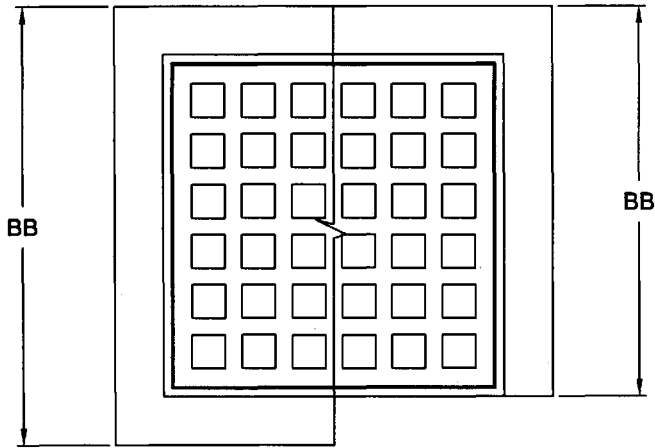

4 - SIDED FRAME 3 - SIDED FRAME

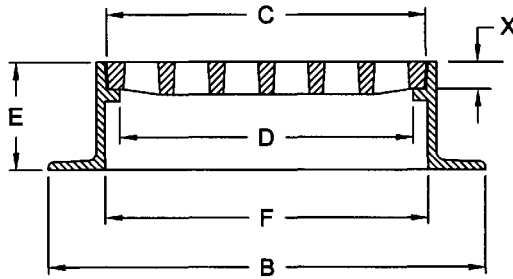

ITEM NUMBER	DIMENSIONS IN INCHES							TYPE OF FRAME
	B	BB	C	D	E	F	X	
22443-SQH	32-3/4	29-1/4	24	22	4	24-1/4	2	3-SIDED
22444-SQH	32-3/4	32-3/4	24	22	4	24-1/4	2	4-SIDED
22463-SQH	32-3/4	29-1/4	24	22	6	24-1/4	2	3-SIDED
22464-SQH	32-3/4	32-3/4	24	22	6	24-1/4	2	4-SIDED
22483-SQH	32-3/4	29-1/4	24	22	8	24-1/4	2	3-SIDED
22484-SQH	32-3/4	32-3/4	24	22	8	24-1/4	2	4-SIDED

**HEAVY DUTY CB FRAMES & SQUARE HOLE GRATES**

SUITABLE FOR A.A.S.H.T.O. H 20-44 AND HS 20-44 HIGHWAY LOADING.

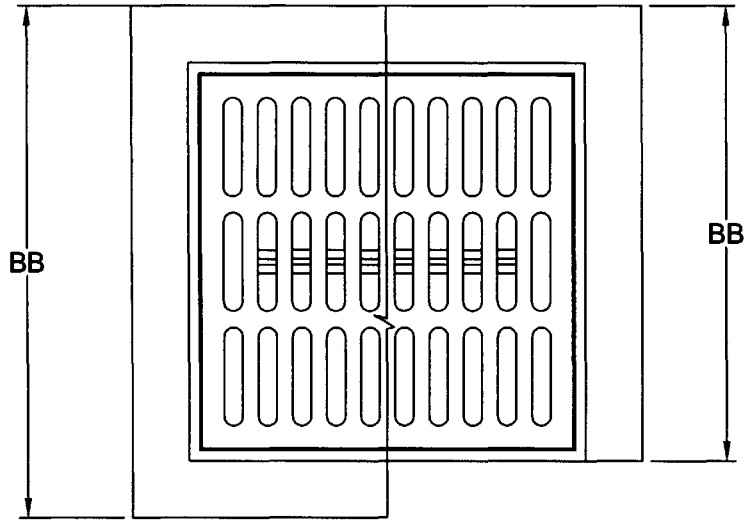

4 - SIDED FRAME      3 - SIDED FRAME

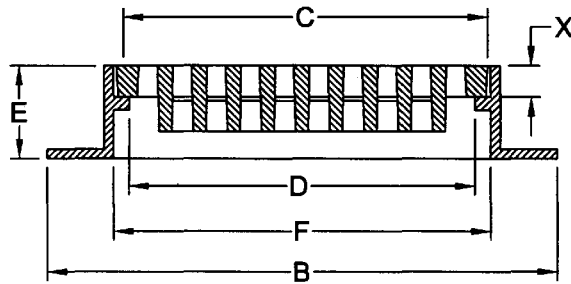

ITEM NUMBER	DIMENSIONS IN INCHES							TYPE OF FRAME
	B	BB	C	D	E	F	X	
22443-BPG	32-3/4	29-1/4	24	22	4	24-1/4	2	3-SIDED
22444-BPG	32-3/4	32-3/4	24	22	4	24-1/4	2	4-SIDED
22463-BPG	32-3/4	29-1/4	24	22	6	24-1/4	2	3-SIDED
22464-BPG	32-3/4	32-3/4	24	22	6	24-1/4	2	4-SIDED
22483-BPG	32-3/4	29-1/4	24	22	8	24-1/4	2	3-SIDED
22484-BPG	32-3/4	32-3/4	24	22	8	24-1/4	2	4-SIDED

**HEAVY DUTY CB FRAMES & BICYCLE PROOF GRATES**

SUITABLE FOR A.A.S.H.T.O. H 20-44 AND HS 20-44 HIGHWAY LOADING.

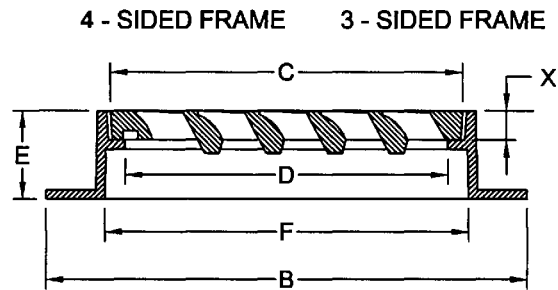
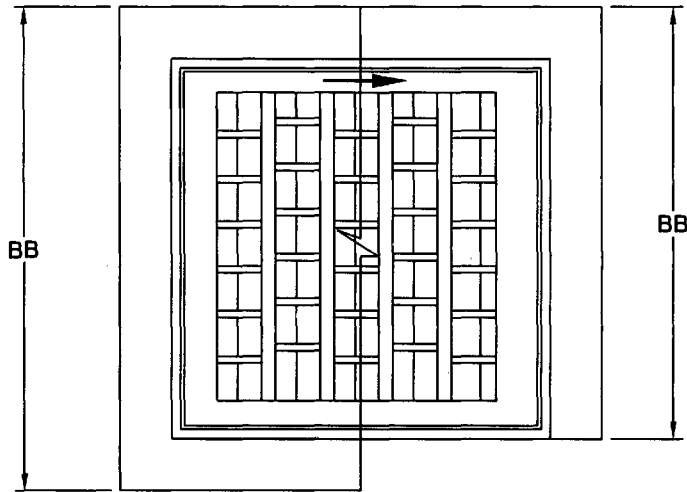

ITEM NUMBER	DIMENSIONS IN INCHES							TYPE OF FRAME
	B	BB	C	D	E	F	X	
22443-CAS	32-3/4	29-1/4	24	22	4	24-1/4	2	3-SIDED
22444-CAS	32-3/4	32-3/4	24	22	4	24-1/4	2	4-SIDED
22463-CAS	32-3/4	29-1/4	24	22	6	24-1/4	2	3-SIDED
22464-CAS	32-3/4	32-3/4	24	22	6	24-1/4	2	4-SIDED
22483-CAS	32-3/4	29-1/4	24	22	8	24-1/4	2	3-SIDED
22484-CAS	32-3/4	32-3/4	24	22	8	24-1/4	2	4-SIDED

NOTE: ARROW ON GRATE REPRESENTS DIRECTION OF FLOW OF WATER. FOR MAXIMUM INFLOW POSITION GRATE ACCORDINGLY.

**HEAVY DUTY CB FRAMES & CASCADE GRATES**

SUITABLE FOR A.A.S.H.T.O. H 20-44 AND HS 20-44 HIGHWAY LOADING.

**GENERAL FOUNDRIES INC.**

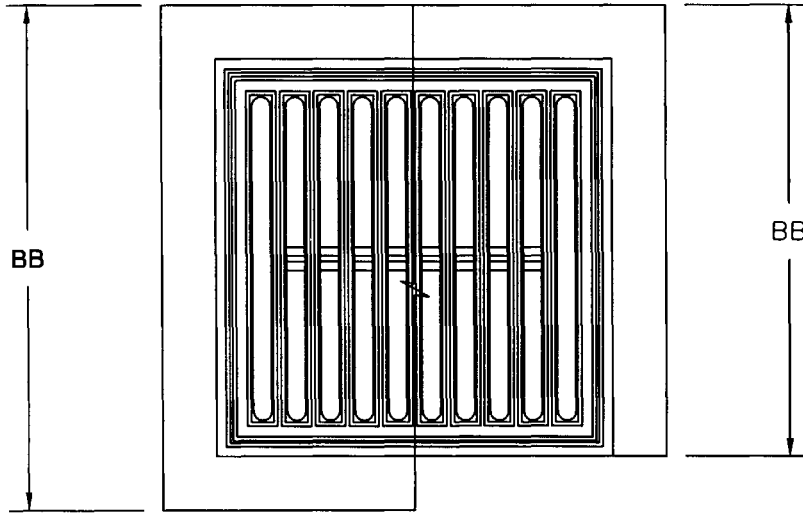

4 - SIDED FRAME      3 - SIDED FRAME

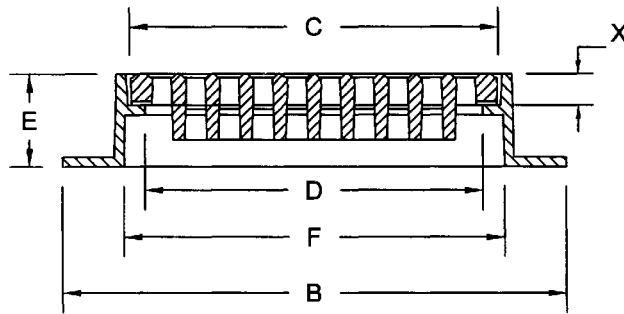

ITEM NUMBER	DIMENSIONS IN INCHES							TYPE OF FRAME
	B	BB	C	D	E	F	X	
22443-BAR	32-3/4	29-1/4	24	22	4	24-1/4	2	3-SIDED
22444-BAR	32-3/4	32-3/4	24	22	4	24-1/4	2	4-SIDED
22463-BAR	32-3/4	29-1/4	24	22	6	24-1/4	2	3-SIDED
22464-BAR	32-3/4	32-3/4	24	22	6	24-1/4	2	4-SIDED
22483-BAR	32-3/4	29-1/4	24	22	8	24-1/4	2	3-SIDED
22484-BAR	32-3/4	32-3/4	24	22	8	24-1/4	2	4-SIDED

**HEAVY DUTY CB FRAMES & BAR GRATES**

SUITABLE FOR A.A.S.H.T.O. H 20-44 AND HS 20-44 HIGHWAY LOADING.

**GENERAL FOUNDRIES INC.**

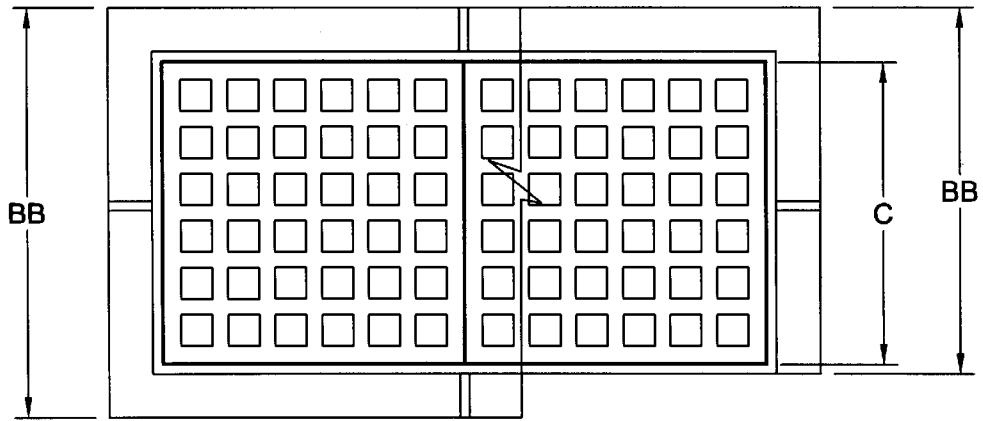

4 - SIDED FRAME

3 - SIDED FRAME

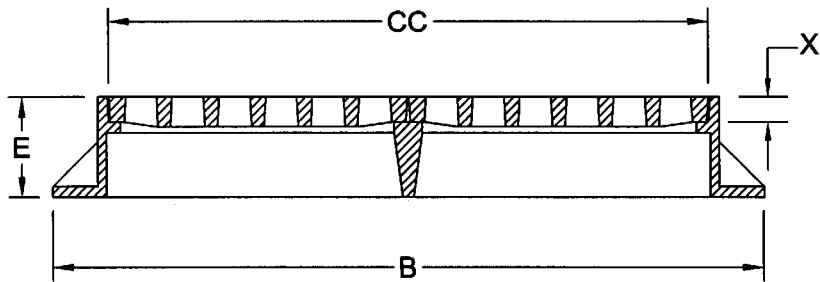

ITEM NUMBER	DIMENSIONS IN INCHES						TYPE OF FRAME
	B	BB	C	CC	E	X	
24843-SQH	56-7/8	29-1/4	24	48	4	2	3-SIDED
24844-SQH	56-7/8	32-3/4	24	48	4	2	4-SIDED
24863-SQH	56-7/8	29-1/4	24	48	6	2	3-SIDED
24864-SQH	56-7/8	32-3/4	24	48	6	2	4-SIDED
24883-SQH	56-7/8	29-1/4	24	48	8	2	3-SIDED
24884-SQH	56-7/8	32-3/4	24	48	8	2	4-SIDED

**HEAVY DUTY DOUBLE CB FRAMES & SQ. HOLE GRATES**

SUITABLE FOR A.A.S.H.T.O. H 20-44 AND HS 20-44 HIGHWAY LOADING.

**GENERAL FOUNDRIES INC.**

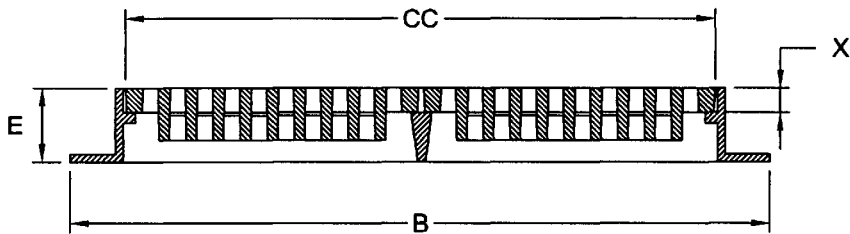
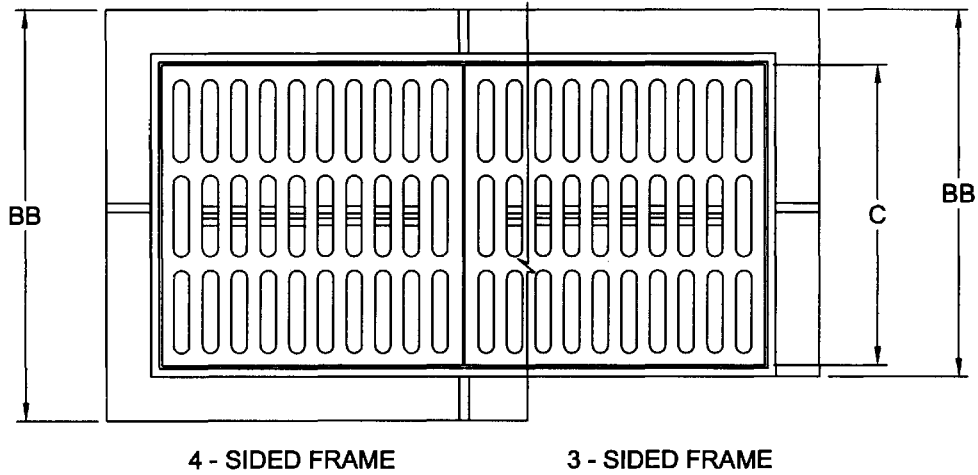

ITEM NUMBER	DIMENSIONS IN INCHES						TYPE OF FRAME
	B	BB	C	CC	E	X	
24843-BPG	56-7/8	29-1/4	24	48	4	2	3-SIDED
24844-BPG	56-7/8	32-3/4	24	48	4	2	4-SIDED
24863-BPG	56-7/8	29-1/4	24	48	6	2	3-SIDED
24864-BPG	56-7/8	32-3/4	24	48	6	2	4-SIDED
24883-BPG	56-7/8	29-1/4	24	48	8	2	3-SIDED
24884-BPG	56-7/8	32-3/4	24	48	8	2	4-SIDED

**HEAVY DUTY DOUBLE CB FRAMES & BP GRATES**

SUITABLE FOR A.A.S.H.T.O. H 20-44 AND HS 20-44 HIGHWAY LOADING.

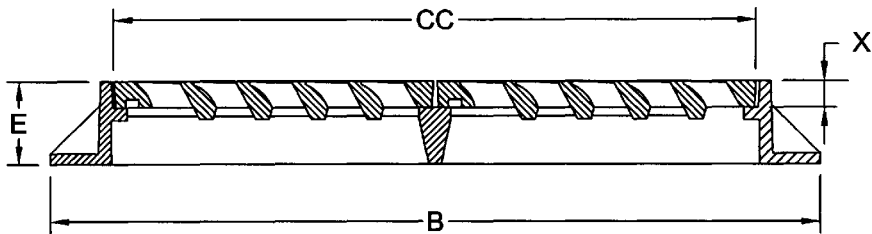
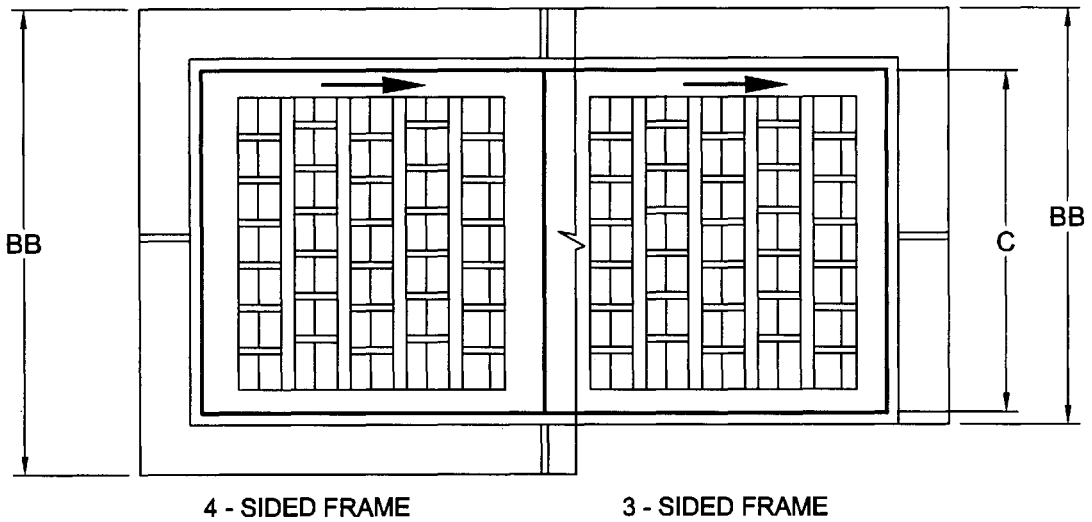

ITEM NUMBER	DIMENSIONS IN INCHES						TYPE OF FRAME
	B	BB	C	CC	E	X	
24843-CAS	56-7/8	29-1/4	24	48	4	2	3-SIDED
24844-CAS	56-7/8	32-3/4	24	48	4	2	4-SIDED
24863-CAS	56-7/8	29-1/4	24	48	6	2	3-SIDED
24864-CAS	56-7/8	32-3/4	24	48	6	2	4-SIDED
24883-CAS	56-7/8	29-1/4	24	48	8	2	3-SIDED
24884-CAS	56-7/8	32-3/4	24	48	8	2	4-SIDED

NOTE: ARROW ON GRATE REPRESENTS DIRECTION OF FLOW OF WATER. FOR MAXIMUM INFLOW POSITION GRATE ACCORDINGLY.

**HEAVY DUTY DOUBLE CB FRAMES & CASCADE GRATES**

SUITABLE FOR A.A.S.H.T.O. H 20-44 AND HS 20-44 HIGHWAY LOADING.

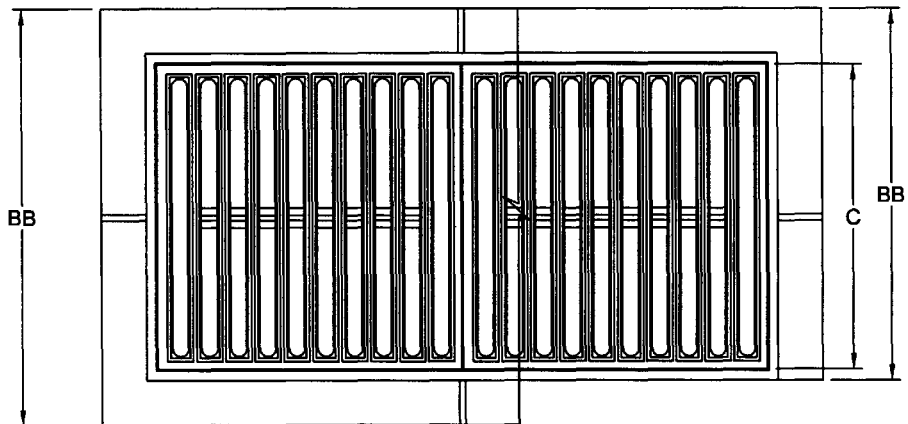

4 - SIDED FRAME

3 - SIDED FRAME

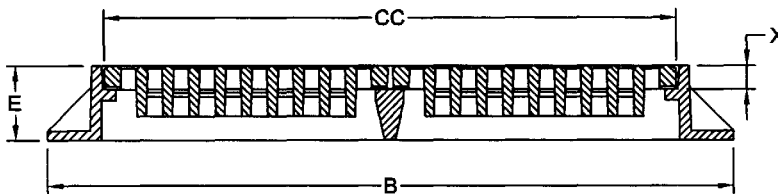

ITEM NUMBER	DIMENSIONS IN INCHES						TYPE OF FRAME
	B	BB	C	CC	E	X	
24843-BAR	56-7/8	29-1/4	24	48	4	2	3-SIDED
24844-BAR	56-7/8	32-3/4	24	48	4	2	4-SIDED
24863-BAR	56-7/8	29-1/4	24	48	6	2	3-SIDED
24864-BAR	56-7/8	32-3/4	24	48	6	2	4-SIDED
24883-BAR	56-7/8	29-1/4	24	48	8	2	3-SIDED
24884-BAR	56-7/8	32-3/4	24	48	8	2	4-SIDED

**HEAVY DUTY DOUBLE CB FRAMES & BAR GRATES**

SUITABLE FOR A.A.S.H.T.O. H 20-44 AND HS 20-44 HIGHWAY LOADING.



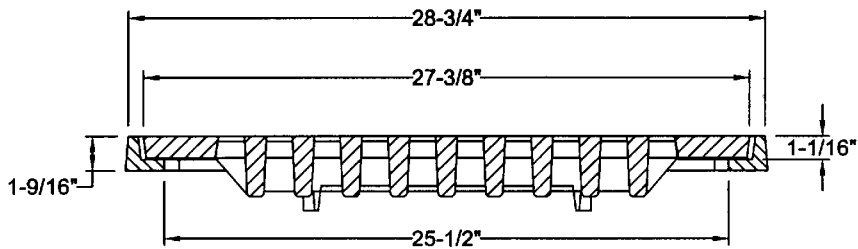
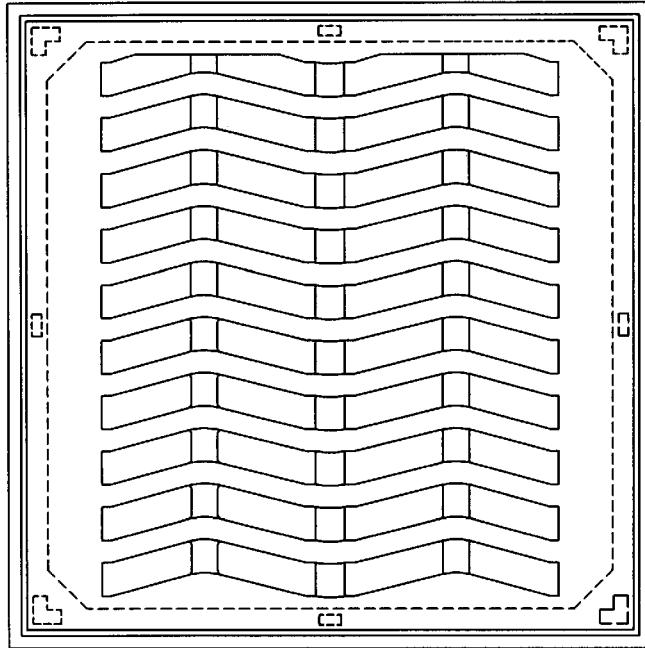

**H.D. ANGLE FRAME & SINUSOIDAL GRATE**

ITEM NUMBER 22716

SUITABLE FOR A.A.S.H.T.O. H 20-44 AND HS 20-44 HIGHWAY LOADING.

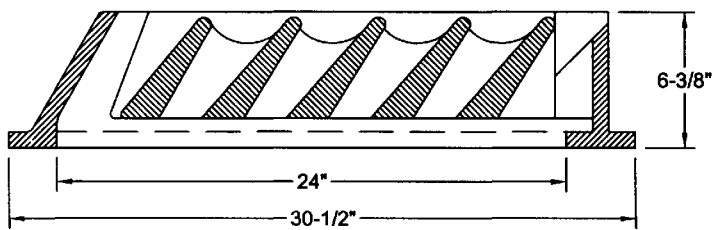
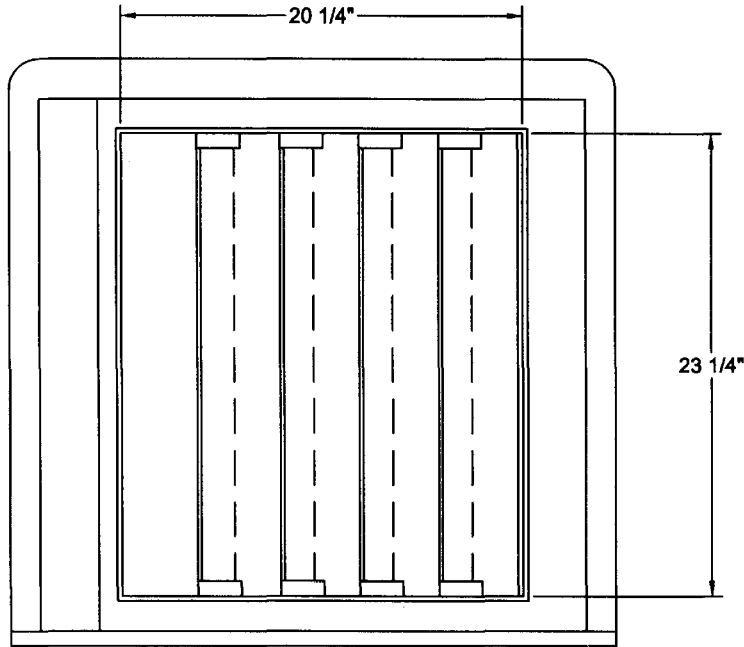

NOTE: ABOVE GRATE IS NOT RECOMMENDED FOR BICYCLE TRAFFIC.

**HEAVY DUTY FRAME & CASCADE GRATE**

ITEM NUMBER 22363

SUITABLE FOR A.A.S.H.T.O. H 20-44 AND HS 20-44 HIGHWAY LOADING.