



Cat. No. 54650-18

sensioTMn156

Portable Multiparameter Meter Manual

TRADEMARKS OF HACH COMPANY

| | | |
|-----------------|--|-------------------------------|
| AccuGrow® | H ₂ O University™ | Pond In Pillow™ |
| AccuVac® | H ₂ OU™ | PourRite® |
| AccuVer™ | Hach Logo® | PrepTab™ |
| AccuVial™ | Hach One® | ProNetic™ |
| Add-A-Test™ | Hach Oval® | Pump Colorimeter™ |
| AgriTrak™ | Hach.com™ | QuanTab® |
| AluVer® | HachLink™ | Rapid Liquid™ |
| AmVer™ | Hawkeye The Hach Guy™ | RapidSilver™ |
| APA 6000™ | HexaVer® | Ratio™ |
| AquaChek™ | HgEx™ | RoVer® |
| AquaTrend® | HydraVer® | <i>sensio</i> ™ |
| BariVer® | ICE-PIC™ | Simply Accurate SM |
| BODTrak™ | IncuTrol® | SINGLET™ |
| BoroTrace™ | Just Add Water™ | SofChek™ |
| BoroVer® | LeadTrak® | SoilSYS™ |
| C. Moore Green™ | M-ColiBlue24® | SP 510™ |
| CA 610™ | ManVer® | SpecV™ |
| CalVer® | MolyVer® | StablCal® |
| ChromaVer® | Mug-O-Meter® | StannaVer® |
| ColorQuik® | NetSketcher™ | SteriChek™ |
| CoolTrak® | NitraVer® | StillVer® |
| CuVer® | NitriVer® | SulfaVer® |
| CyaniVer® | NTrak® | Surface Scatter® |
| Digesdahl® | OASIS™ | TanniVer® |
| DithiVer® | On Site Analysis. Results You Can Trust SM | TenSette® |
| Dr. F. Fluent™ | OptiQuant™ | Test 'N Tube™ |
| Dr. H. Tueau™ | OriFlow™ | TestYES! SM |
| DR/Check™ | OxyVer™ | TitraStir® |
| EC 310™ | PathoScreen™ | TitraVer® |
| FerroMo® | PbEx® | ToxTrak™ |
| FerroVer® | PermaChem® | UniVer® |
| FerroZine® | PhosVer® | VIScreen™ |
| FilterTrak™ 660 | Pocket Colorimeter™ | Voluette® |
| Formula 2533™ | Pocket Pal™ | WasteAway™ |
| Formula 2589™ | Pocket Turbidimeter™ | ZincoVer® |
| Gelex® | | |

TABLE OF CONTENTS

| | |
|---|----|
| SAFETY PRECAUTIONS | 7 |
| SPECIFICATIONS..... | 9 |
| OPERATION | 13 |
| SECTION 1 INTRODUCTION | 15 |
| 1.1 Unpacking the Instrument | 15 |
| 1.1.1 Standard Accessories..... | 15 |
| 1.1.2 Optional Accessories | 16 |
| 1.2 Keypad Description | 16 |
| 1.3 Screen Description and Layout | 18 |
| 1.4 Maintenance | 20 |
| 1.5 Audible Signals | 20 |
| SECTION 2 INSTRUMENT SETUP | 21 |
| 2.1 Instrument Description..... | 21 |
| 2.2 Power Connection | 21 |
| 2.2.1 Using the Docking Station as a Power Source | 21 |
| 2.2.2 Docking Station Connections | 23 |
| 2.2.3 Using Batteries as a Power Source | 23 |
| 2.3 Probe Connections..... | 24 |
| 2.3.1 Switching Between Conductivity and Dissolved Oxygen Modes | 24 |
| 2.3.2 Attaching the Probe Holder to the Instrument | 25 |
| 2.4 Turning the Meter On..... | 25 |
| 2.5 Setup Menu Features Common to All Parameters | 25 |
| 2.6 Printer and Computer Connections | 26 |
| 2.7 Automatic Shut-off Function | 26 |
| 2.8 Display Backlight..... | 26 |
| SECTION 3 pH OPERATION MODE | 27 |
| 3.1 pH Setup Menu Options..... | 27 |
| 3.2 How to Change the pH Menu Options | 28 |
| 3.3 pH Calibration | 30 |
| 3.3.1 Performing a Calibration Using Automatically Recognized Buffers | 30 |
| 3.3.2 Performing a Manual Calibration | 31 |
| 3.3.3 Reviewing the Calibration | 32 |
| 3.4 Measuring Samples | 33 |
| 3.5 Millivolt Measurement | 33 |

TABLE OF CONTENTS, continued

| | |
|---|----|
| SECTION 4 CONDUCTIVITY OPERATION MODE | 35 |
| 4.1 Conductivity Setup Menu Options | 35 |
| 4.2 How to Change the Conductivity Menu Options..... | 37 |
| 4.3 Conductivity Calibration..... | 39 |
| 4.3.1 Calibrating with a Known Standard | 39 |
| 4.3.2 Calibrating by Adjusting the Cell Constant | 40 |
| 4.3.3 Reviewing Calibrations | 41 |
| 4.4 Measuring Conductivity | 41 |
| 4.4.1 Measuring Low Levels of Conductivity | 42 |
| 4.5 Measuring Total Dissolved Solids | 43 |
| 4.6 Measuring Salinity | 43 |
| 4.7 Substances that May Affect Measurement | 44 |
| 4.8 Common Conversion Factors..... | 44 |
| 4.9 Theory of Conductivity Measurement | 45 |
| SECTION 5 DISSOLVED OXYGEN OPERATION MODE | 47 |
| 5.1 Dissolved Oxygen Setup Menu Options..... | 47 |
| 5.2 How to Change the Dissolved Oxygen Menu Options..... | 47 |
| 5.3 DO Probe | 48 |
| 5.3.1 Probe Assembly..... | 48 |
| 5.4 Dissolved Oxygen Calibration..... | 50 |
| 5.4.1 Probe Polarization | 50 |
| 5.4.2 Zeroing the Probe | 51 |
| 5.4.3 Calibration in Water Saturated Air..... | 52 |
| 5.4.4 Calibration to a Known Dissolved Oxygen Concentration | 53 |
| 5.4.5 Calibrating a Sample to Read 100% Saturation | 54 |
| 5.4.6 Calibration Review | 55 |
| 5.5 Measuring Dissolved Oxygen..... | 56 |
| 5.5.1 General Probe Operation | 56 |
| 5.5.2 Dissolved Oxygen Measurement | 56 |
| 5.5.3 Probe Storage | 57 |
| 5.5.4 Maintenance | 58 |
| 5.6 Using the BOD Accessory Kit..... | 58 |
| 5.7 Making BOD Determinations..... | 59 |
| 5.8 Measuring Dissolved Oxygen in Water (0 to 20 mg/L)..... | 59 |
| 5.9 Salinity Correction Factors | 63 |
| 5.10 Pressure Conversions | 64 |

TABLE OF CONTENTS, continued

| | |
|---|----|
| SECTION 6 STORING AND RECALLING DATA | 65 |
| 6.1 Storing Measurements | 65 |
| 6.2 Recalling Stored Data | 66 |
| 6.2.1 pH Data | 67 |
| 6.2.2 Conductivity Data | 67 |
| 6.2.3 Dissolved Oxygen Data | 68 |
| 6.3 Erasing Data | 68 |
| 6.3.1 Erasing Single Data Points | 68 |
| 6.3.2 Erasing Multiple Data Points | 69 |
| SECTION 7 PRINTING AND DATA TRANSFER | 71 |
| 7.1 Connecting to Printers/Computers | 71 |
| 7.1.1 RS232 Cable Description | 71 |
| 7.1.2 Connecting to a Printer | 71 |
| 7.1.3 Connecting to a Personal Computer | 73 |
| 7.1.4 Using HachLink™ Communications Software with a PC | 74 |
| 7.2 Sending Data to Printers/Computers | 74 |
| 7.2.1 Sending Currently Displayed Data | 74 |
| 7.2.2 Sending Recalled Data Points | 74 |
| 7.2.3 Sending Multiple Data Points | 75 |
| 7.3 Printed Data Formats | 76 |
| 7.3.1 pH Printed Data Format | 76 |
| 7.3.2 Conductivity Printed Data Format | 76 |
| 7.3.3 Dissolved Oxygen Printed Data Format | 76 |
| SECTION 8 TROUBLESHOOTING | 77 |
| 8.1 Error Codes | 77 |
| 8.2 Meter Service Request Questionnaire | 78 |
| GENERAL INFORMATION | 79 |
| REPLACEMENT PARTS AND ACCESSORIES | 81 |
| HOW TO ORDER | 85 |
| REPAIR SERVICE | 86 |
| WARRANTY | 87 |
| CERTIFICATION | 89 |

SAFETY PRECAUTIONS

Please read this entire manual before unpacking, setting up, or operating this instrument. Pay particular attention to all danger and caution statements. Failure to do so could result in serious injury to the operator or damage to the equipment.

To ensure the protection provided by this equipment is not impaired, do not use or install this equipment in any manner other than that which is specified in this manual.

Use of Hazard Information

If multiple hazards exist, this manual will use the signal word (Danger, Caution, Note) corresponding to the greatest hazard.

DANGER

Indicates a potentially or imminently hazardous situation which, if not avoided, could result in death or serious injury.

CAUTION

Indicates a potentially hazardous situation that may result in minor or moderate injury.

NOTE

Information that requires special emphasis.

Precautionary Labels

Read all labels and tags attached to the instrument. Personal injury or damage to the instrument could occur if not observed.

 This symbol, if noted on the instrument, references the instruction manual for operational and/or safety information.

 ***Section 2.2 Power Connection***

 ***Section 2.3 Probe Connections***

 ***Section 2.6 Printer and Computer Connections***

 ***Section 7.1 Connecting to Printers/Computers***

SPECIFICATIONS

Specifications subject to change without notice.

General Specifications

Display: Custom LCD

Inputs:

- (1) 5-pin Hach pH/mV/temperature probe connector
- (1) 5-pin Hach conductivity or dissolved oxygen probe connector

Outputs: RS232 via Docking Station

Power requirements:

Meter: 4 AA alkaline batteries or via Docking Station

Docking Station: 6–12 V dc; use either Hach-supplied 115 or 230 V, 50/60 Hz external power supply or a customer-provided supply with 50 mA output, 5.5-mm power plug with a 2.5 mm center post (positive).

Input impedance: $>10^{12}$ ohms

Installation Category: II (for 115V and 230V external power supplies)

Environmental Requirements: 0–50 °C at 85% non-condensing relative humidity

Meter dimensions: 21.2 x 8.7 x 4.2 cm (8.35 x 3.43 x 1.65 inches)

Enclosure: Waterproof (designed to meet IP67), chemical-resistant, dust proof; meter will float. Docking station is water-resistant to IP40.

SPECIFICATIONS, continued

pH Mode

Range: -2.00–19.99

Resolution (selectable): 0.001/0.01/0.1

Slope (meter allowable): 48–65 mV/decade

Instrument Drift: <40 $\mu\text{V}/^\circ\text{C}$

Input Bias Current: -1 pico amp \leq input bias \leq 1 pico amp at 25 $^\circ\text{C}$; ± 4 picoamp over full range

Millivolt Mode

Range: -2000–2000 mV

Resolution: 0.1 mV

Accuracy (meter only): ± 0.2 mV or $\pm 0.15\%$ of the reading, whichever is greater

Temperature

Range: -10.0–110 $^\circ\text{C}$

Resolution: 0.1 $^\circ\text{C}$

Accuracy: ± 0.3 $^\circ\text{C}$ from 0–70 $^\circ\text{C}$; ± 1.0 $^\circ\text{C}$ from 70–110 $^\circ\text{C}$

Conductivity Mode

Range: 0–19.99 μS ; 20–199.9 $\mu\text{S}/\text{cm}$; 200–1999 $\mu\text{S}/\text{cm}$;
2–19.99 mS/cm; 20–199.9 mS/cm

TDS: 0–50,000 mg/L as NaCl

Salinity: 0–42 ppt (‰)

Temperature: -10–105 $^\circ\text{C}$

Resolution:

Conductivity:

0.00–19.99 $\mu\text{S}/\text{cm}$ 0.01 $\mu\text{S}/\text{cm}$

20.0–199.9 $\mu\text{S}/\text{cm}$ 0.1 $\mu\text{S}/\text{cm}$

200–1999 $\mu\text{S}/\text{cm}$ 1 $\mu\text{S}/\text{cm}$

2.00–19.99 mS/cm 0.01 mS/cm

20.0–199.9 mS/cm 0.1 mS/cm

SPECIFICATIONS, continued

Resolution:

TDS:

| | |
|-----------------|----------|
| 0.00–199.9 mg/L | 0.1 mg/L |
| 200–1999 mg/L | 1 mg/L |
| 2.00–19.99 g/L | 0.01 g/L |
| 20.0–50 g/L | 0.1 g/L |

Salinity:

0.1 ppt (‰)

Temperature

±0.1 °C

Accuracy:

Conductivity: ±0.5% of range

TDS: ±0.5% of full scale

Salinity: ±0.1 ppt (-2 to 35°C)

Temperature: ±0.3 °C from 0–70 °C;

±1.0 °C from 70–110 °C

Conversion Factor for TDS: automatic or user adjustable

Temperature Compensation:

Manual (user selected coefficient, % per °C) or

Automatic (non-linear based on NaCl solutions)

Dissolved Oxygen Mode

Range: 0–20 mg/L (ppm), 0–200% sat.

Accuracy: ±1% full scale

Temperature: 0–50 °C

Resolution:

Oxygen Concentration: 0.01 or 0.1 ppm (mg/L)

% Saturation: 0.1%

Temperature: 0.1 °C

Instrument drift: < 1%/day



OPERATION

DANGER

Handling chemical samples, standards, and reagents can be dangerous. Review the necessary Material Safety Data Sheets and become familiar with all safety procedures before handling any chemicals.

DANGER

La manipulation des échantillons chimiques, étalons et réactifs peut être dangereuse. Lire les Fiches de Données de Sécurité des Produits (FDSP) et se familiariser avec toutes les procédures de sécurité avant de manipuler tous les produits chimiques.

PELIGRO

La manipulación de muestras químicas, estándares y reactivos puede ser peligrosa. Revise las fichas de seguridad de materiales y familiarícese con los procedimientos de seguridad antes de manipular productos químicos.

GEFAHR

Das Arbeiten mit chemischen Proben, Standards und Reagenzien ist mit Gefahren verbunden. Es wird dem Benutzer dieser Produkte empfohlen, sich vor der Arbeit mit sicheren Verfahrensweisen und dem richtigen Gebrauch der Chemikalien vertraut zu machen und alle entsprechenden Material Sicherheitsdatenblätter aufmerksam zu lesen.

PERIGO

A manipulação de amostras, padrões e reagentes químicos pode ser perigosa. Reveja a folha dos dados de segurança do material e familiarize-se com todos os procedimentos de segurança antes de manipular quaisquer produtos químicos.

The portable *sens^{ion}™156* Multiparameter Meter measures pH, conductivity, and dissolved oxygen. Other features include:

- User-friendly calibration
- 199-point internal datalogging for each of the three parameters
- Automatic shut-off (15 minutes after the last key press)
- Automatic correction for barometric pressure, and salinity
- Sealed keypad provides IP67 water resistance
- Ability to send data to a printer or computer through the Docking Station
- Use of alkaline batteries or a Docking Station for power

1.1 Unpacking the Instrument

Remove the instrument and accessories from the shipping container and inspect each item for damage. Verify that all items listed on the packing slip are included. If any items are missing or damaged, contact Hach Customer Service, Loveland, Colorado at 1-800-227-4224. Customers outside the United States should contact their regional Hach office or distributor.

1.1.1 Standard Accessories

- Batteries—4 alkaline (not rechargeable)
- *sens^{ion}156* Multiparameter Meter Instrument Manual

Depending on which configuration you ordered, you will receive two or more of the following:

- pH electrode
- Conductivity electrode
- Dissolved oxygen electrode
- Removable dual probe holder

SECTION 1, continued

1.1.2 Optional Accessories

- Docking Station
- Stirring Stand
- BOD Accessory Kit (See *Section 5.6* on page 58.)
- Low Ionic Strength Sample Chamber
- Probe-related accessories (covered in the electrode manual)
- Carrying case

1.2 Keypad Description

Figure 1 shows the keypad. *Table 1* explains key functions.

Figure 1 *sensioN156* Meter and Keypad

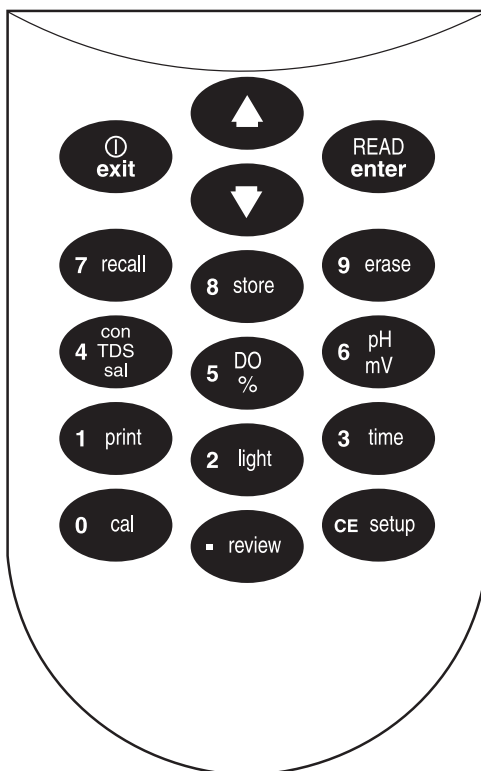

SECTION 1, continued

Table 1 Keys and Description

| Key | Description |
|---------------------------------------|---|
| Exit/Power On-Off | When power is off: <ul style="list-style-type: none"> • Turns the instrument on and opens the most recently used reading mode. In Reading mode: <ul style="list-style-type: none"> • Turns the instrument off. From other power modes: <ul style="list-style-type: none"> • Exits the current mode and moves toward power off. • Acts as a “no” answer when the question mark is flashing. • Cancels the current operation without saving changes. |
| UP ARROW and DOWN ARROW | Scroll between options in setup mode. Scroll through data points in Store and Recall modes. Scroll between the option to print or erase one data point and the option to print or erase multiple data points. |
| READ/ENTER | Accepts numerical input. Acts as a “yes” answer when the question mark is flashing. Allows user to edit a setup when the setup number is flashing. Accepts the current setup option when that option is flashing. Initiates a measurement when the meter has stabilized in the Display Lock Enabled mode and during calibration. |
| RECALL | Recalls stored sample data of the current reading parameter type (from Reading mode only). |
| STORE | Initiates storage of the displayed measurement (from Reading mode only). |
| ERASE | Erases recalled data points. |
| CON/TDS/SAL | Initiates conductivity reading. Toggles between conductivity, total dissolved solids, and salinity. |
| pH/mV | Initiates pH reading. Toggles between pH and mV. |
| DO % | Initiates dissolved oxygen reading. Toggles between dissolved oxygen concentrations displayed as % saturation and mg/L in Reading, Data Recall, and Calibration Review modes. |
| PRINT | Sends current or recalled data to a printer or a computer via the RS232 port on the docking station. From Cal Review, prints current calibration data. |
| TIME | From Reading Mode, shows current time (one press) and date (two presses). In Recall Data and Calibration Review modes, the key toggles between the time and date of the stored measurement. |
| CAL | Enters Calibration mode (from Reading mode only). |
| REVIEW | Enters Calibration Review mode (from Reading mode only). |
| SETUP/CE | Enters setup mode (from Reading mode only). Clears a numeric entry when the keypad icon is displayed. |
| LIGHT | Turns the backlight on and off. |

1.3 Screen Description and Layout

The screen, also known as the display, is divided into two areas by a horizontal line. The upper area shows measurements or standard values, the current operation mode, sample temperature, units, error codes, and a stable reading indicator. The lower area shows the active navigation keys (**ENTER**, **EXIT**, or **UP ARROW** and **DOWN ARROW** keys). It also shows when the numeric keypad is active and AC power is connected via the Docking Station.

Figure 2 shows the icons and fields that appear on the display. Table 2 describes each icon and field. To see all icons simultaneously, hold down the **POWER** key for several seconds.

Figure 2 *sensION156* Display Layout

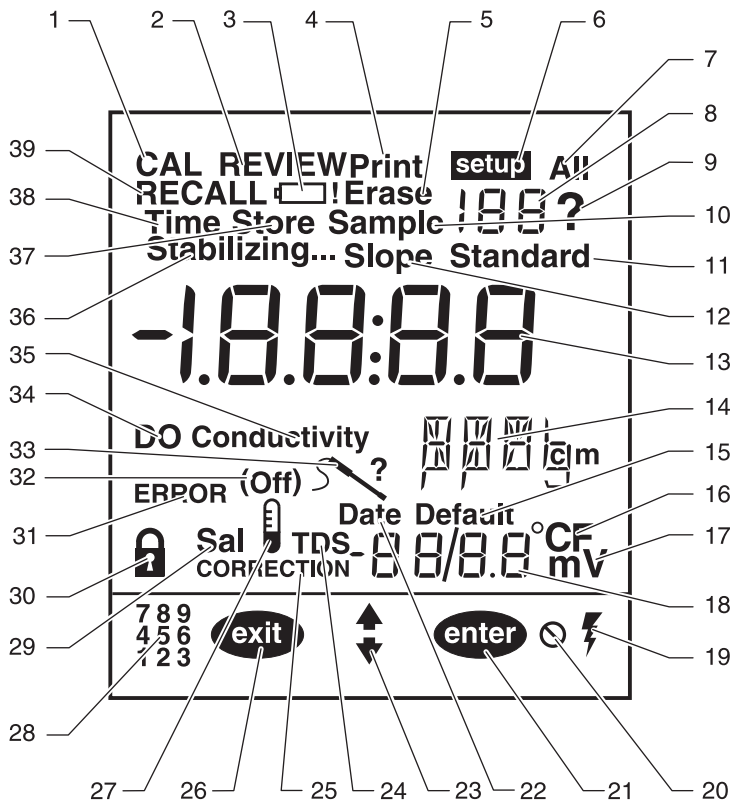

SECTION 1, continued

Table 2 Display Descriptions

| Item No. | Description |
|----------|--|
| 1 | Indicates meter is in Calibration mode. When this icon and the ? are flashing, a calibration is necessary. |
| 2 | Indicates meter is in Calibration Review mode. |
| 3 | Indicates the battery is low. |
| 4 | Indicates data is being or will be sent to a printer/computer, or that a printing setup has been accessed. |
| 5 | Indicates currently displayed recalled data is being or will be erased. |
| 6 | Indicates meter is in setup mode. |
| 7 | Indicates all data points are being printed or erased. Also used when displaying pH average. |
| 8 | Refers to Setup , Sample , or Standard when any of those words are displayed next to the number. For example, if Standard and 1 are displayed, the meter is measuring Standard 1. |
| 9 | When flashing along with the CAL icon, indicates that calibration is needed for the current reading parameter. Otherwise, it indicates that user input is required. (In this case, press ENTER for “yes” and EXIT for “no”.) |
| 10 | Label for sample number in Data Store, Recall, or Erase modes. |
| 11 | Indicates the meter is measuring a standard (standard number is displayed above). |
| 12 | Indicates the displayed number is the electrode slope. |
| 13 | Main numeric display field. Displays values for readings, slope, and setups. |
| 14 | Indicates measurement units. |
| 15 | Indicates the meter is using the default temperature to calculate temperature correction. (Probe temperature sensor is not functioning.) |
| 16 | Indicates the temperature units in use (choice of °C or °F). |
| 17 | Indicates value displayed in small numerical field (item 18) is in millivolts. |
| 18 | Displays temperature value, date, or pH calibration offset. |
| 19 | Indicates the meter is using AC power (only displayed when in the docking station). |
| 20 | Indicates an inactive key has been pressed and that function is not allowed. |
| 21 | Indicates the ENTER key is active. |
| 22 | Indicates the date is being set (in Setup mode) or displayed (in Reading, Cal Review, or Data Recall mode). |
| 23 | Indicates arrow keys are active. |
| 24 | Indicates that the instrument is reading or recalling conductivity in terms of TDS. If correction icon is also on, it indicates that the TDS correction factor has been changed from the factory default. |
| 25 | Indicates that the meter is in Correction mode. Indicates that one or more correction factor setups have been changed from their default settings. These include salinity correction for DO, and temperature and/or TDS correction factors for conductivity. |

SECTION 1, continued

Table 2 Display Descriptions (Continued)

| Item No. | Description |
|----------|---|
| 26 | Indicates EXIT key is active. |
| 27 | If the thermometer icon and the correction icon are on, a temperature correction other than the factory default is in use. If it is on with the (Off) icon, temperature compensation is turned off. |
| 28 | Indicates numeric key functions are active. |
| 29 | In Conductivity mode, it indicates the meter is displaying sample salinity. In DO mode, indicates that the salinity correction is being applied to the dissolved oxygen measurement and that the salinity corrected value is displayed. |
| 30 | Indicates the display is locked. Pressing read initiates another measurement. |
| 31 | Indicates a meter function problem. |
| 32 | Indicates whether an associated setup setting is On or Off . |
| 33 | Indicates faulty probe connection or incorrect probe attached. |
| 34 | Indicates that the meter is reading or recalling a dissolved oxygen measurement. |
| 35 | Indicates that the instrument is reading or recalling a conductivity measurement. |
| 36 | Indicates the signal from the sample is not yet stable. When the icon disappears, the reading is stable and may be recorded. |
| 37 | Asks if the calibration or the displayed sample data should be stored. Used with ? icon. |
| 38 | Indicates the time is being displayed or set. Used with large display (item 13). |
| 39 | Indicates the meter is in Recall mode and the displayed data is stored data. |

1.4 Maintenance

The meter is designed to be maintenance-free. If the meter gets dirty, wipe the surface with a damp cloth. Use a cotton-tipped applicator to clean or dry the connectors if they get wet.

1.5 Audible Signals

The meter will beep under certain conditions:

- when a non-functional key press is made (one beep)
- when measurement stability is reached during calibration (three beeps)
- in Reading mode, when the display lock is turned on and stability is reached (three beeps)
- in case of an error or malfunction (one beep).

2.1 Instrument Description

The portable *sensio*TM156 Multiparameter Meter is designed for field or laboratory use and operates on four alkaline batteries. Alternatively, use a docking station connected to 115/230 V ac. See *Section 2.2.1*.

2.2 Power Connection

2.2.1 Using the Docking Station as a Power Source

The *sensio* Docking Station (*Figure 3*) is the ac adapter for the meter. It also allows users to send data from the meter to a printer or computer. To connect the Docking Station to the meter:

1. Plug the external power supply into a wall outlet and plug the ac/dc power connector into the Docking Station.
2. Place the instrument on the Docking Station so the three metal connector pins on the bottom of the meter align with the three protruding metal connectors.
3. When the meter is using ac power, the ac power icon will appear in the lower right corner of the display.

Connection to ac power is not necessary to download data to a printer or computer with the RS232 interface.

The Docking Station will not charge rechargeable batteries. Use a separate alkaline battery charger.

Removing the alkaline batteries supplied with the instrument is not necessary when using the Docking Station.

When the Docking Station and meter are connected, the Docking Station disables the meter's automatic shut-off function.

SECTION 2, continued

Figure 3 Using the sens*ion* Docking Station



SECTION 2, continued

2.2.2 Docking Station Connections

The Docking Station has a power connector, a serial port, and a green indicator light on the back. The standard 9-pin RS232 serial port connector on the Docking Station is used for sending data to a printer or computer. Adapters, such as a 9-pin to 25-pin connector, may be required.

The green light on the Docking Station lights when a connection is made to a computer and flickers when data is being transferred to a printer or computer via the serial port.

2.2.3 Using Batteries as a Power Source



CAUTION
Use only alkaline batteries in this product. Other types of batteries can result in safety hazards.

PRUDENCE

Utiliser seulement des piles alcalines dans cet appareil. Les autres types de piles peuvent créer des risques pour la sécurité.

ATENCIÓN

Utilice solamente baterías alcalinas en este producto. El uso de otros tipos de baterías puede causar riesgos de seguridad.

VORSICHT

Verwenden Sie in diesem Produkt nur Alkali-Batterien. Die Verwendung anderer Batterien gefährdet die Betriebssicherheit.

ATENÇÃO

Use somente baterias alcalinas neste produto. Outros tipos de baterias podem resultar em risco a segurança.

1. Turn the instrument off.
2. Hold the meter upside down and slide the battery compartment cover off of the meter as shown in *Figure 4*.
3. Insert the AA alkaline batteries in the battery compartment as shown.
4. Replace the battery compartment cover by sliding it onto the instrument case until it snaps into position.

SECTION 2, continued

Figure 4 Installing Batteries in the Meter

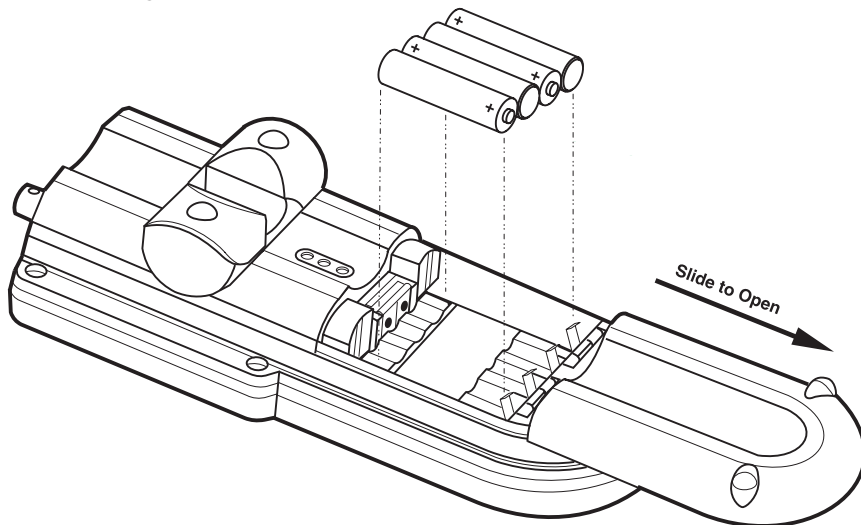

2.3 Probe Connections

Attach electrodes with 5-pin connectors to the sensor input by lining the pins up with the holes in the meter port (see *Figure 5*). Push the electrode connector toward the instrument.

Figure 5 Electrode Connectors

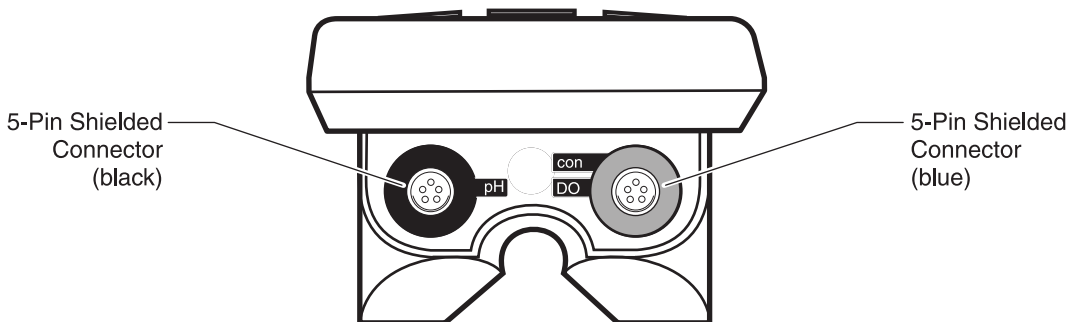

2.3.1 Switching Between Conductivity and Dissolved Oxygen Modes

The blue connector is for either the DO or conductivity probe. The meter remembers which of these probes was used last. If you select the parameter that was not used last, the meter will prompt for an electrode change and ask you to confirm. Press **ENTER** to confirm the new probe and initiate the reading. Press **EXIT** to return the meter to the previous mode.

SECTION 2, continued

2.3.2 Attaching the Probe Holder to the Instrument

Figure 6 Attaching the Probe Holder to the instrument

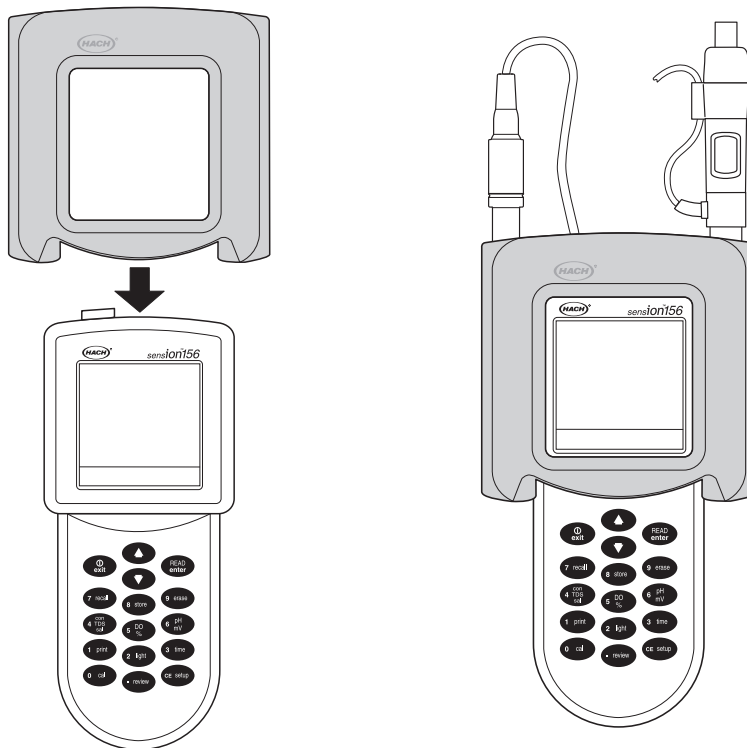

2.4 Turning the Meter On

After plugging the Docking Station into the wall or installing batteries, turn the instrument on by pressing the **IO** key (located on the upper left side of the keypad). The display will show the software version number, perform internal tests, then default to the most recent reading mode.

2.5 Setup Menu Features Common to All Parameters

The setup menu structure on the *sensIon156* Multiparameter Meter varies depending on the reading mode (pH, conductivity, or dissolved oxygen). **The setups for Time, Date, Year, Temperature, and Units apply to all parameters.** Other menu setups, including Display Lock, Auto Print Interval, and Resolution, allow users to select different settings for different parameters.

2.6 Printer and Computer Connections

The meter can send data to a computer or printer via the 9-pin serial port (see *Figure 7*). **The printer cable and computer cable are different.** The printer cable is a 9-pin to 25-pin cable; the computer cable is a 9-pin to 9-pin cable. Use the correct cable.

The meter can print to serial printers without an adapter. For parallel printers, a converter and cable adapter are required. The Citizen PN60 printer requires a special Citizen adapter.

Figure 7 Serial Port, 9-pin

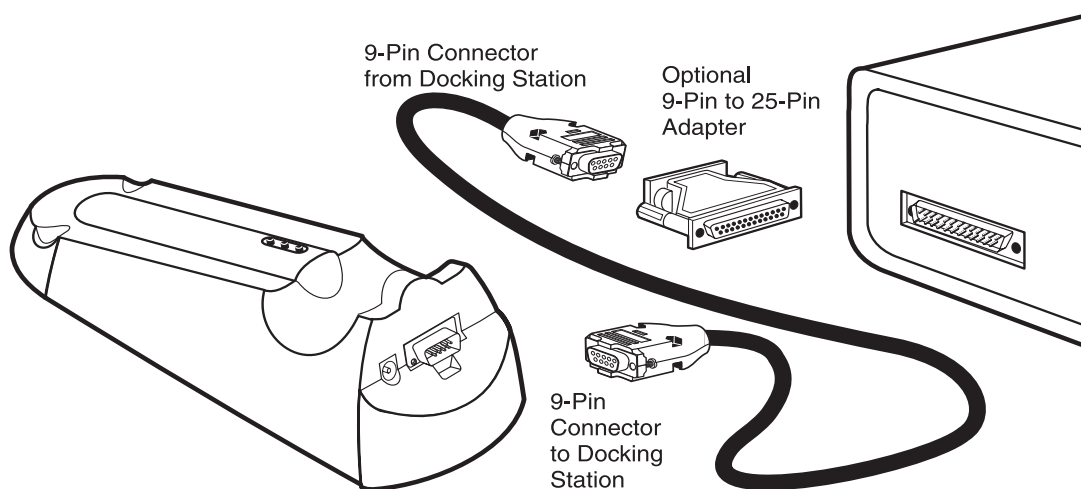

2.7 Automatic Shut-off Function

Note: Automatic shutoff is disabled when automatic printing at timed intervals is selected.

The meter is equipped with an automatic shut-off feature that turns the meter off 15 minutes after the last key press. (However, if the meter is in Calibration mode, automatic shut-off occurs four hours after the last key press). Press the **I/O** key to turn the instrument on again.

2.8 Display Backlight

In low light conditions, turn on the backlight by pressing the **LIGHT** key on the keypad. To turn the light off, press the **LIGHT** key again. The light will also turn off when the instrument automatically shuts off, or when the user turns the instrument off.

3.1 pH Setup Menu Options

Table 3 describes the options available in the pH Setup Menu.

Table 3 pH Setup Options

| Setup Number | Setup Description | Option Description | Default Setting |
|--------------|-------------------------|---|-----------------|
| 1 | Time | 00:00 to 23:59 | 00:00 |
| 2 | Date | 01/01 to 12/31 | 01/01 |
| 3 | Year | 2000–2099 | 2000 |
| 4 | Temperature units | °C, °F | °C |
| 5 | Display lock | On: Lock icon Off: Lock icon and (Off) icon | Off |
| 6 | Resolution | 0.0, 0.00, 0.000 | 0.00 |
| 7 | Auto buffer recognition | 6.86 pH, 7.00 pH | 7.00 pH |
| 8 | Auto print interval | Off, 10 sec., 30 sec., 1 min., 5 min., 20 min., 1 hr., 2 hrs., and 6 hrs. | Off |

Display Lock — When Display Lock is on, the stable reading is locked on the display. A new reading is initiated by pressing the **READ** key. When Display Lock is off, the meter will continuously monitor pH. **Stabilizing . . .** may appear again if the sample pH is changing or the probe drifts. The default setting is off.

pH, DO, and conductivity have separate Display Lock settings.

Auto Buffer Recognition — Allows users to select 7.00 pH or 6.86 pH as the automatically recognized, mid-range buffer. Do not use 6.86 pH buffer if the setting is 7.00 pH. Do not use 7.00 pH buffer if the setting is 6.86 pH.

Auto Print Interval — This function activates the automatic data transfer (Print) function. The Docking Station is required to send data to a printer or computer via the RS232 connection.

The automatic data transfer function automatically sends data through the docking station depending upon the time interval selected. Time intervals are selected from the following options: 10 seconds, 30 seconds, 1 minute, 5 minutes, 20 minutes, 1 hour, 2 hours, or 6 hours. The default setting is “off”.

SECTION 3, continued

Accessing the Calibration mode or the Setup mode halts automatic data transfer. Also, if the meter has been set to the Lock mode using Setup 1, the meter will not send data. When the meter is in Lock mode and the **READ** key is pressed, automatic data transfer will occur at selected time intervals only until the meter stabilizes and the value in the display is locked.

To keep transferring pH data, leave the meter in pH Reading mode on a docking station.

Each time data transfer occurs, the Print icon will momentarily appear at the top of the display.

When Auto Print is on, the instrument will send data at the specified interval, as long as the instrument is in the pH Reading mode.

3.2 How to Change the pH Menu Options

To access the pH Setup menu:

1. Turn on the meter and press the **pH** key.
2. Press the **SETUP** key.
3. Use the **UP ARROW** and **DOWN ARROW** keys to scroll between the desired options.

Table 4 shows how to change each specific setup option.

SECTION 3, continued

Table 4 How to Change pH Menu Options

| Setup | How to Get There |
|------------------------------------|---|
| Setup 1 Time | From any reading mode, press SETUP . Press ENTER . Use the number keys to change the time. Press ENTER to accept the time. |
| Setup 2 Date | From any reading mode, press SETUP . Press the UP ARROW until the setup number is 2. Press ENTER . Press the UP or DOWN arrow to toggle the date format between d/M (day/month) and m/d (month/day). Use the number keys to change the date. Press ENTER to accept the date. |
| Setup 3 Year | From any reading mode, press SETUP . Press the UP ARROW until the setup number is 3. Press ENTER . Use the number keys to change the year. Press ENTER to accept the year. |
| Setup 4 Temperature Units | From any reading mode, press SETUP . Press the UP ARROW until the setup number is 4. Press ENTER to toggle between °C and °F. The default is °C. When the desired option is selected, press EXIT to return to the reading mode. |
| Setup 5 Display Lock | From pH Reading mode, press SETUP . Press the UP ARROW until the setup number is 5. Press ENTER to toggle display lock off and on. When the desired option is selected, press exit to return to the reading mode. <i>Note: When display lock is disabled, the Display Lock icon and (Off) are displayed. When this feature is enabled, only the Display Lock icon is displayed.</i> See <i>Section 3.1</i> for more information about this setup. |
| Setup 6 Measurement Resolution | From pH Reading mode, press SETUP . Press the UP ARROW until the setup number is 6. Press ENTER to toggle between the three resolution options. When the desired option is selected, press EXIT to return to the reading mode. |
| Setup 7 Auto Buffer Recognition | From pH Reading mode, press SETUP . Press the UP ARROW until the setup number is 7. Press ENTER to toggle between the buffer value of 6.86 and 7.00. When the desired option is selected, press EXIT to return to the reading mode. See <i>Section 3.1</i> for more information about this setup. |
| Setup 8 Auto Print Intervals | From pH Reading mode, press SETUP . Press the UP ARROW until the setup number is 8. Press ENTER . Change the print interval by pressing the UP ARROW and DOWN ARROW keys. Press ENTER to accept the print interval. |

3.3 pH Calibration

Hach recommends a daily two- or three-point calibration using buffers that bracket the sample pH. Store and compare the daily slope values to verify that the electrode is working properly.

3.3.1 Performing a Calibration Using Automatically Recognized Buffers

1. Prepare two or three pH buffers according to the electrode instruction manual. Choose from 1.68, 4.01, 7.00 (or 6.86), 10.01, and 12.45 pH buffers.

Note: Use a 6.86 or 7.0 pH buffer for the mid-range buffer. To view or change the setting for the mid-range buffer see Section 3.2.

2. Turn the instrument on. From the pH Reading mode, press **CAL**. **CAL** and flashing ? will appear in the upper display area, along with **Standard** and **1**.
3. Place the pH electrode in one of the buffers.
4. Press **READ**. The instrument will automatically recognize the calibration buffer value. The temperature and pH values will be updated until a stable reading is reached.

Note: The pH values for the buffers are given for 25 °C. If the calibration buffer temperature is not 25 °C, the pH values displayed for the buffers will reflect the correct pH value for the calibration buffer temperature.

*Note: If the meter is measuring in pH mode, it automatically moves to the next calibration step when the reading stabilizes (indicated by three beeps). If measuring in mV mode, the meter beeps three times when the reading stabilizes. Press **ENTER** to accept the reading.*

5. When the reading has stabilized or been accepted, the standard number will change to **2**.
6. Remove the probe from the first buffer and rinse with deionized water. Place the probe in the second buffer.
7. Press **READ**. The temperature and pH values will be updated until a stable reading is reached.

SECTION 3, continued

8. When the reading has stabilized or been accepted, the standard number will change to **3**. (To accept this calibration after two points, press **EXIT**. Press **ENTER** to accept the calibration or **EXIT** to cancel the calibration without saving it.)
9. Remove the probe from the second buffer and rinse with deionized water. Place the probe in the third buffer.
10. Press **READ**. The temperature and pH values will be updated until a stable reading is reached.
11. When the reading has stabilized or been accepted, the slope value and the **Store** and **?** icons will appear.
12. To save the calibration and return to the reading mode, press **ENTER**. To exit the calibration without saving it and return to the reading mode, press **EXIT**.

3.3.2 Performing a Manual Calibration

1. Prepare two or three pH buffers according to the electrode instruction manual.
2. Turn the instrument on. From the pH Reading mode, press **CAL**. Functional keys will appear in the lower left display area. **CAL** and **?** will appear in the upper display area, along with **Standard** and **1**. The numeric keypad will become active.
3. Place the pH electrode in a buffer (starting with the lowest pH makes it easy to keep track).
4. Enter the pH value of the buffer using the number keys and press **ENTER**. A flashing underscore (___) indicates where the next number will be placed.
5. The pH value entered will appear and the temperature and pH values will be updated until a stable reading is reached.
6. When the reading has stabilized, the standard number will change to **2**. (If measuring in the mV mode, press **ENTER** to accept the reading and continue.)
7. Rinse the electrode and place it in the next buffer.

SECTION 3, continued

8. Enter the pH value of the buffer using the number keys as described above. Press **ENTER**.
9. When the reading has stabilized, the standard number will change to 3. (If measuring in the mV mode, press **ENTER** to accept the reading and continue.)
10. If desired, repeat *steps 7–9* for a third buffer. If not, press **EXIT** and go to the next step.
11. The slope value and the **Store** and **?** icons will appear.
12. To save the calibration and return to the reading mode, press **ENTER**. To exit the calibration without saving it and return to the reading mode, press **EXIT**. After the calibration is stored, the meter is immediately ready to begin measuring samples. See *Section 3.4* on page 33 for pH sample measurements.

3.3.3 Reviewing the Calibration

1. From the pH Reading mode, press the **REVIEW** key.
2. The meter will display the time the calibration was stored. Press the **UP ARROW** and **DOWN ARROW** keys to scroll through the calibration data shown below.

| Information Shown in Calibration Review |
|--|
| Date and time of calibration |
| Standard 1, pH and temperature of Standard 1 |
| Standard 2, pH and temperature of Standard 2 |
| Standard 3, pH and temperature of Standard 3 (if applicable) |
| Slope and offset (corrected to 25 °C) |

Note: View mV value by pressing **mV**.

3. To print the calibration review data, press **PRINT** while reviewing the calibration data.
4. To exit Cal Review mode, press **EXIT**.

SECTION 3, continued

3.4 Measuring Samples

After successful calibration, follow the steps below to measure samples. See the electrode manual for more information and specific procedures that use the electrode.

1. Rinse the electrode in deionized water.
2. Place the electrode in the sample. Press **READ. Stabilizing...** will appear, along with the sample temperature and the pH or mV reading. These values may fluctuate until the system is stable.
3. When the reading is stable **Stabilizing...** will disappear. If the Display Lock is enabled, the display will “lock in” on the pH or mV and sample temperature. If the Display Lock is off, the display will show the current reading and temperature, but the values may fluctuate.
4. Record or store the pH or mV value.
5. Remove the electrode from the sample, rinse with deionized water and place the electrode in the next sample. Repeat *steps 2–4* for each sample.
6. When finished, turn the meter off. Rinse the electrode with deionized water and gently blot dry. Replace the protective cap on the electrode and put the electrode in the electrode holder. Consult the electrode manual for storage instructions.

3.5 Millivolt Measurement

The meter can measure absolute millivolts (mV). To display the current millivolt reading, press the **mV** key from the pH Reading mode. The mV value is displayed with **mV** in the units field.

Absolute millivolts are displayed with 0.1 mV resolution in the range of -2000 to 2000.

4.1 Conductivity Setup Menu Options

Table 5 describes the options available in the Conductivity Setup menu.

Table 5 Setup Options

| Setup Number | Setup Description | Option Description | Default Setting |
|--------------|--|--|---|
| 1 | Time | 00:00 to 23:59 | 00:00 |
| 2 | Date | 01/01 to 12/31 | 01/01 |
| 3 | Year | 2000–2099 | 2000 |
| 4 | Temperature units | °C, °F | °C |
| 5 | Display lock | On: Lock icon Off: Lock icon and (Off) icon | Off |
| 6 | Temperature Correction Factor (Thermometer icon) | Non-linear NaCl or $\frac{[\text{Numeric value}]\%}{^{\circ}\text{C}}$ | Non-linear NaCl |
| 7 | TDS Correction Factor | Non-linear NaCl or numeric value for converting $\mu\text{S}/\text{cm}$ to TDS | NaCl in units field |
| 8 | Auto-print interval | Off, 10 sec., 30 sec., 1 min., 5 min., 20 min., 1 hr., 2 hrs., and 6 hrs. | Off |
| 9 | Reference Temperature Selection (Thermometer icon) | 20° C or 25° C | 25° C |
| 10 | Temperature Correction (Thermometer icon) | On, Off (Off) icon for off | On. If “raw” conductivity is desired, such as with a soil cup, turn off temperature correction. |

Temperature Correction Value — Allows selection of a linear or non-linear temperature correction function. The non-linear coefficient has been determined from measurements using aqueous NaCl solutions; for most freshwater samples, this is the best setting. If the linear function is chosen, the measured conductivity values are automatically temperature-corrected based on the specified temperature coefficient and the selected reference temperature. The linear temperature correction value for the meter has a default value of 2% per 1 °C.

SECTION 4, continued

Conductivity of samples that contain other salts or ions may change at a different rate with temperature. This rate depends on the solution temperature, the ion concentration, and the reference temperature selected, and should be determined experimentally. Once determined, enter the temperature correction value using this setup option.

The Temperature Correction option must be on for the meter to use a temperature correction value (see *Section 4.2*).

Table 6 shows some typical temperature coefficients (percent change of conductivity per °C).

Table 6 Percentage Change of Conductivity per Degree C

| Solution | Percent/°C |
|------------------|------------|
| Ultrapure Water | 4.55 |
| Salt (NaCl) | 2.125 |
| NaOH | 1.72 |
| Dilute Ammonia | 1.8810 |
| 10% HCl | 1.325 |
| 5% Sulfuric Acid | 0.9698 |
| Sugar Syrup | 5.64 |

TDS Correction Factor — This setup lets the user choose a linear or non-linear conversion from conductivity to TDS. TDS measurements use conductivity readings that are temperature-compensated. When the linear conversion is chosen, the meter uses the reference temperature and the temperature-correction option to determine temperature-corrected conductivity. The non-linear (NaCl) conversion uses the non-linear temperature correction function and a reference temperature of 25 °C, regardless of the current temperature factor setting (Setup 6), to convert temperature-compensated conductivity readings to TDS readings.

In Reading mode, the TDS icon indicates the meter is reading TDS. If the correction icon is also shown, the meter is using a linear conversion. If the correction icon does not appear, the meter is using the default non-linear NaCl conversion.

Reference Temperature — Conductivity standards typically have a reference temperature noted on their container. When measuring solutions that are not at the reference temperature, the meter automatically adjusts the reading to the conductivity value that would have been measured if the sample had been at the reference temperature. The reference temperature choices in the meter are 20 or 25 °C. The reference temperature default setting is 25 °C.

Temperature Correction Off and On — Because the activity of ions in solutions varies with temperature, conductivity measurements are typically corrected for the sample temperature. To obtain conductivity measurements that are not temperature corrected (i.e., using the soil cup), turn this option off. For typical measurements, ignoring the effects of temperature can result in significant error. Salinity and TDS always require temperature compensation, so when those forms of conductivity are being measured, this setup is ignored. The probe supplied with the meter measures temperature with a thermistor for automatic temperature compensation.

When the thermometer and Off icons appear in the Read mode, the instrument is not correcting the measured conductivity for temperature.

In Setup mode, when the setting is disabled, the thermometer icon and **(Off)** are displayed. When this feature is enabled, the thermometer icon is displayed without the **(Off)** icon.

4.2 How to Change the Conductivity Menu Options

To access the Conductivity Setup menu:

1. Turn on the meter and press the **CON** key. The arrow icons that appear indicate that additional options are available within the menu.
2. Press the **SETUP** key.
3. Use the **UP ARROW** and **DOWN ARROW** keys to scroll between the desired options.

SECTION 4, continued

To set the time, date, year, or temperature units, remain in Conductivity mode, but follow the instructions in *Table 4* on page 29. *Table 7* shows how to change the other setup options.

Table 7 How to Change Conductivity Menu Options

| Setup | How to Get There |
|---|--|
| <p>Setup 5 Display Lock</p> | <p>From Conductivity Reading mode, press SETUP. Press the UP ARROW until the setup number is 5. Press ENTER to toggle display lock off and on. When the desired option is selected, press EXIT to return to the reading mode. When display lock is disabled, the Display Lock icon and Off are displayed. When this feature is enabled, only the Display Lock icon is displayed. See <i>Section 4.1</i> for more information about this setup.</p> |
| <p>Setup 6 Temperature Correction Value</p> | <p>From Conductivity Reading mode, press SETUP. Press the UP ARROW until the setup number is 6. Press ENTER. To select the non-linear function, press the UP or DOWN ARROW key until the display shows NaCl. Press ENTER to accept the setting.</p> <p>To select a linear conversion, scroll until the correction coefficient appears (e.g., 2.000%). Enter the desired value using the numeric keypad. Press ENTER to accept the value. If a number entry error occurs, start over by pressing CE.</p> <p><i>Note: If the compensation factor is set to 0.00%, the conductivity readings will not be corrected for temperature.</i></p> <p>When the desired option is selected, press EXIT to return to the reading mode. See <i>Section 4.1</i> for more information about this setup.</p> |
| <p>Setup 7 TDS Correction Factor</p> | <p>From Conductivity Reading mode, press SETUP. Press the UP ARROW until the setup number is 7. Press ENTER. Press the UP or DOWN ARROW keys to switch between linear and non-linear correction functions. To choose a non-linear conversion, scroll until a flashing NaCl appears, then press ENTER. To select a linear conversion, scroll until the conversion coefficient appears. Use the numeric keypad to set the value of the coefficient, then press ENTER. If a number entry error occurs, start over by pressing CE.</p> <p>When the desired option is selected, press EXIT to return to the reading mode. See <i>Section 4.1</i> for more information about this setup.</p> |
| <p>Setup 8 Auto Print Intervals</p> | <p>From Conductivity Reading mode, press SETUP. Press the UP ARROW until the setup number is 8. Press ENTER. Change the print interval by pressing the UP ARROW and DOWN ARROW keys. Press ENTER to accept the print interval.</p> |

SECTION 4, continued

Table 7 How to Change Conductivity Menu Options (Continued)

| Setup | How to Get There |
|---|--|
| Setup 9 Reference Temperature | From Conductivity Reading mode, press SETUP . Press the UP ARROW until the setup number is 9 . Press ENTER to toggle between 20° C and 25° C. The default is 25° C. Press EXIT to return to the reading mode. See <i>Section 4.1</i> for more information about this setup. |
| Setup 10 Temperature Correction Off and On | From Conductivity Reading mode, press SETUP . Press the UP ARROW until the setup number is 10 . Press ENTER to toggle between (off) and on. Press EXIT to return to the reading mode. See <i>Section 4.1</i> for more information about this setup. |

4.3 Conductivity Calibration

Calibrate the meter before use. There are two ways to calibrate the meter:

1. Use NaCl standards of known electrolytic conductivity. See *Section 4.3.1* for instructions on this calibration method.
2. Enter/adjust the cell constant of the conductivity probe. See *Section 4.3.2* for instructions on this calibration method.

4.3.1 Calibrating with a Known Standard

Hach's Conductivity probe is shipped with a 1000 $\mu\text{S}/\text{cm}$ (at 25 °C) NaCl standard solution. For typical applications with conductivity of 0–10,000 μS (10 mS/cm), calibrate with this standard to achieve the accuracy specified for the meter. Outside this range, calibrate using a standard that lies closer to the measurement range. In general, using a calibration standard that is closer to your measurement range results in greater accuracy. Hach offers several conductivity standards.

1. Make sure the meter is in Conductivity Reading mode.
2. Place the probe in a conductivity standard that is in the expected range of the samples. Agitate the probe to dislodge bubbles in the cell. Avoid resting the probe on the bottom or side of the container.
3. Press **CAL**. Icons that represent the active navigation keys will appear in the lower part of the display.

SECTION 4, continued

The meter will recall the most recent type of calibration. Look at the units field to see what kind of calibration is active. The units will be one of the following forms:

| Units | Calibration Method |
|------------------|--|
| $\mu\text{S/cm}$ | Known standard expressed in $\mu\text{S/cm}$ |
| mS/cm | Known standard expressed in mS/cm |
| $1/\text{cm}$ | Enter/adjust cell constant (see <i>Section 4.3.2</i>) |

4. Scroll to the preferred units using the **UP** or **DOWN ARROWS**.
5. Use the number keys to change the numeric value, if desired. The value entered must be the standard's conductivity value at a reference temperature of 25 °C.

Note: All Hach standards have the conductivity value corresponding to the 25 °C reference temperature printed on their labels.

It is not necessary to fill up the numeric entry screen before moving on. To clear the numeric display, press **CE**.

6. When the value and units are correct, press **ENTER** to calibrate on the standard. The meter automatically corrects the calibration measurement to the 25 °C reference temperature using the NaCl-based, non-linear temperature coefficient.
7. The meter will return to Conductivity Reading mode when the calibration is finished.

4.3.2 Calibrating by Adjusting the Cell Constant

The cell constant should be consistent over most of the measurement range. However, samples having a conductivity higher than 50 mS/cm may have a slightly different cell constant than samples with a conductivity less than 50 mS/cm . Follow the steps below to measure samples with conductivity above and below 50 mS/cm without recalibrating.

1. Follow *Section 4.3.1* to calibrate the meter. Be sure the meter is in the Conductivity mode before calibrating it.
2. After the calibration is complete, press **REVIEW**. The cell constant for the probe will be displayed. Record this value.

SECTION 4, continued

3. Press the **UP ARROW** to display the standard concentration value. Record this value. Press **EXIT**.
4. As the conductivity of the sample measurements change, the cell constant can be updated without calibrating with a standard. First, press **CAL**.
5. Functional keys will appear in the lower part of the display. **CAL** and **?** will appear in the upper display. The main display will show the last value used for calibration.
6. Press the **DOWN ARROW** until the current cell constant is displayed (in cm^{-1}).
7. Use the numeric keypad to enter the cell constant from a previous calibration that applies to the current sample. If a number entry error occurs, start over by pressing **CE**.
8. Press **ENTER**. When the calibration is complete, the meter will return to measurement mode.

4.3.3 Reviewing Calibrations

1. From the Reading mode, press the **REVIEW** key.
2. To print a calibration report, press the **PRINT** key.
3. The display will show the date of the most recent calibration. Press the **TIME** key to see the calibration time. Press the **UP ARROW** to continue.
4. The display will show the value of the standard used for calibration. Go to *step 5* if the calibration was performed by setting the cell constant. Otherwise, press the **UP ARROW** once.
5. The meter will display the current cell constant in cm^{-1} . To exit Cal Review mode, press **EXIT**.

4.4 Measuring Conductivity

To measure conductivity with the *sensioN156* meter, press the **CON/TDS/SAL** key until the conductivity icon appears in the lower left corner of the screen. (The TDS and Sal icons do not appear.) The instrument will automatically select the appropriate range and units and will display the conductivity value for the sample being measured.

For conductivity, place the probe into the sample and make sure the slot on the end of the probe is totally immersed. Agitate the sample with the probe for 5–10 seconds to remove bubbles that may be trapped in the slot.

Table 8 shows the conductivity ranges of common solutions.

Table 8 Conductivity Range of Common Aqueous Solutions

| Sample Type | Conductivity Range |
|-----------------------------|---|
| High pressure boiler water | <0.1 $\mu\text{S/cm}$ to 0.2 $\mu\text{S/cm}$ |
| Deionized water | 1 $\mu\text{S/cm}$ to 80 $\mu\text{S/cm}$ |
| Drinking water | 100 $\mu\text{S/cm}$ to 1 mS/cm |
| Wastewater | 85 $\mu\text{S/cm}$ to 9 mS/cm |
| Surface water | 100 $\mu\text{S/cm}$ to 10 mS/cm |
| Industrial process water | 8 mS/cm to 130 mS/cm |
| Concentrated acids and dyes | 85 mS/cm to >1000 mS/cm |

4.4.1 Measuring Low Levels of Conductivity

When the non-temperature corrected conductivity is less than 1 $\mu\text{S/cm}$, the meter automatically uses the temperature correction coefficients for pure water for the reference temperature selected (derived from *ASTM method D 1125-91*, page 253, 1993).

For greatest accuracy, Hach recommends using the Low Ionic Strength Chamber to prevent gases in the atmosphere from changing the conductivity level.

1. Make sure the meter is using the non-linear NaCl temperature correction (see *Section 4.2* on page 37).
2. Zero the dry probe by pressing **READ** and **CAL** at the same time. Then insert the conductivity probe into the LIS chamber. Start the sample flow into the LIS chamber.

SECTION 4, continued

3. When the conductivity value stabilizes, store or record it.

Note: *If the non-temperature-corrected conductivity of the sample increases above 1 $\mu\text{S}/\text{cm}$, the meter will use the temperature correction coefficients for NaCl. This may cause a noticeable jump in the displayed conductivity reading.*

4.5 Measuring Total Dissolved Solids

To measure TDS with the *sensio156* meter, press the **CON/TDS/SAL** key until the TDS icon appears in the lower left corner of the screen. The instrument will display the TDS value for the currently displayed conductivity measurement.

The standard method of determining TDS is to evaporate the sample to dryness at 180 °C, then weigh the residue. Alternatively, calculate the concentration of sodium chloride that would have the same conductivity as the sample at the same temperature. The *sensio156* meter reports a sample's TDS value in mg/L of sodium chloride by comparing the sample conductivity and temperature to data stored in the meter's memory. Data were obtained from empirical procedures using sodium chloride solutions.

4.6 Measuring Salinity

To measure salinity with the *sensio156* meter, press the **CON/TDS/SAL** key until the SAL icon appears in the lower left corner of the screen. The instrument will display the salinity value for the sample being measured.

Salinity, a measure of the mass of dissolved salts in a given mass of solution, is used to describe seawater, natural, and industrial waters. Salinity is a relative scale based on a potassium chloride (KCl) solution. A salinity value of 35 is equivalent to a KCl solution containing 32.4356 g KCl in 1 kg of solution at 15 °C. Salinity is measured in ‰ (ppt—parts per thousand). The meter calculates the salinity based on the Extended Practical Salinity Scale of 1978, as referenced in 17th edition of *Standard Methods*, 25200 B. The applicable range is 0 to 42‰ and -2 to 35 °C.

If you have a DO probe and plan to use salinity measurements to adjust DO measurements, follow the steps below:

SECTION 4, continued

1. From Salinity mode, press the **UP ARROW**. The instrument will ask whether you would like to use the current measurement as the salinity correction factor for DO measurements.
2. Press **ENTER** to accept or **EXIT** to cancel. If you select **ENTER**, Setup 7 in DO mode changes accordingly.

4.7 Substances that May Affect Measurement

When measuring very low conductivity levels ($< 2 \mu\text{S}$), protect the sample from gasses such as ammonia or carbon dioxide. These gases cause rapid changes in the conductivity when they dissolve into water. To avoid this problem, measure conductivity using the Low Ionic Strength Chamber.

Pretreat water that is likely to contain high amounts of hydroxides (boiler water) with Gallic Acid Solution. Untreated samples may result in falsely high values. To pretreat the sample:

1. Add four drops of Phenolphthalein Indicator Solution to the sample.
2. Stirring constantly, add Gallic Acid Solution until the pink/red color disappears. The solution will become colorless if a small amount of hydroxides are present, or it may turn brownish-yellow if large amounts of hydroxides are present. Adding too much Gallic Acid can increase the conductivity, so add the minimum amount to achieve the color change.

4.8 Common Conversion Factors

The *sensio156* meter converts conductivity readings to TDS and salinity values at the touch of a key. *Table 9* lists more conversion factors that may be useful.

Table 9 Conversions

| To Convert From | To | Use This Equation |
|------------------|---------------------|-------------------------------|
| mS/cm | $\mu\text{S/cm}$ | $\text{mS/cm} \times 1000$ |
| $\mu\text{S/cm}$ | mS/cm | $\mu\text{S/cm} \times 0.001$ |
| $\mu\text{S/cm}$ | $\mu\text{mhos/cm}$ | $\mu\text{S/cm} \times 1$ |
| mS/cm | mmhos/cm | $\text{mS/cm} \times 1$ |
| g/L TDS | mg/L TDS | $\text{g/L TDS} \times 1000$ |

Table 9 Conversions (Continued)

| | | |
|----------|---------|--------------------|
| mg/LTDS | g/L TDS | mg/L TDS x 0.001 |
| mg/L TDS | gpg TDS | mg/L TDS x 0.05842 |
| g/L TDS | gpg TDS | g/L TDS x 58.42 |
| μS/cm | ohms•cm | 1,000,000 ÷ μS/cm |
| mS/cm | ohms•cm | cm 1,000 ÷ mS/cm |

4.9 Theory of Conductivity Measurement

Conductivity is the ability of a material to conduct current. Positive and negative ions in a solution will move to the oppositely charged electrode when an electric charge is applied to the solution, thus conducting current. In addition to the current applied, ion movement is affected by the solvent properties (temperature, viscosity) and the physical properties of the ion (size, charge, concentration...). As temperature increases, ions move faster and conduct more current. As viscosity increases, the ions move slower and conduct less current.

In theory, a conductivity measuring cell consists of two, 1-cm square electrode surfaces spaced 1 cm apart. The cell constant (K) is determined by the cell length (L) and cross-sectional area (A) ($K = L \div A$). The theoretical cell just described has a cell constant of $K = 1.0 \text{ cm}^{-1}$. Cells with larger/smaller electrodes or electrodes spaced at a different distance are characterized by a different cell constant.

The Hach Conductivity measuring system has an innovative two-cell probe design. With this design, a single probe can take measurements within the full, dynamic range of the instrument. Less advanced conductivity measurement systems that use single-cell probes require the user to purchase several probes, each of which measures only a portion of the instrument's range.

Electrolytic conductivity is not the same as specific conductivity. Electrolytic conductivity is a property of the solution being measured; specific conductivity includes the property of the measuring cell, partially defined by its physical design. By defining the physical parameters of the cell, a standard measure is created. This standard measure (specific conductivity) is reciprocal of the resistance (1/ohm), measured between the opposing faces of 1 cm cube of liquid at a specific temperature.

SECTION 4, continued

The S.I. unit for conductivity is Siemens (S) (1 Siemen = 1 mho). Other units are: $1/\text{ohm} = 1 \text{ mho} = 1000 \text{ mS} = 1,000,000 \mu\text{S}$.

Since the cell's physical configuration significantly affects the conductivity measurement, it must be multiplied by the conductance to obtain the actual conductivity reading. For example, if the conductance reading is $350 \mu\text{S}$ using a cell with $K = 0.1 \text{ cm}^{-1}$, the conductivity value is $350 \times 0.1 = 35.0 \mu\text{S/cm}$.

Simply stated, the cell constant is defined as the ratio of the distance between the electrodes (d) to the electrode area (A). However, this neglects the existence of a fringe-field effect, which affects the electrode area by the amount AR . Therefore:

$$K = d/(A + AR)$$

Normally it is not possible to measure the fringe-field effect and the amount of AR to calculate the cell constant. For most uses, the actual cell constant (K) of a specific cell is determined by comparing the measurement of a standard solution of known specific conductivity (e.g., 0.01 M KCl) to the measured conductance.

The conductivity of a solution at a specific electrolyte concentration will change if the temperature changes. For accuracy, measured values should be adjusted for the solution temperature. The temperature-compensated conductivity of a solution is the conductivity that the solution exhibits at the reference temperature. This temperature is either $25 \text{ }^\circ\text{C}$ or $20 \text{ }^\circ\text{C}$. A measurement made at reference temperature does not need compensation.

The *sension156* meter automatically compensates for temperature during conductivity measurements using the sample temperature. Temperature compensation is different for different types of samples. Some examples are shown in *Table 6* on page 36. The closer the sample is to the reference temperature, the smaller the error will be if the meter temperature coefficient is not correct.

SECTION 5

DISSOLVED OXYGEN OPERATION MODE

5.1 Dissolved Oxygen Setup Menu Options

Table 10 describes the options available in the Dissolved Oxygen Setup Menu.

Table 10 Setup Options

| Setup Number | Setup Description | Option Description | Default Setting |
|--------------|---------------------|---|-----------------|
| 1 | Time | 00:00 to 23:59 | 00:00 |
| 2 | Date | 01/01 to 12/31 | 01/01 |
| 3 | Year | 2000–2099 | 2000 |
| 4 | Temperature units | °C, °F | °C |
| 5 | Display lock | On: Lock icon Off: Lock icon and (Off) icon | Off |
| 6 | Resolution | 0.0, 0.00 | 0.00 |
| 7 | Salinity Factor | 0–40 | 0 |
| 8 | Auto-print interval | Off, 10 sec., 30 sec., 1 min., 5 min., 20 min., 1 hr., 2 hrs., and 6 hrs. | Off |

Salinity Factor — This feature adjusts the displayed dissolved oxygen concentration in mg/L based on the sample's salinity.

When the **Sal** icon is displayed during the reading mode, a salinity correction calculation is applied to the dissolved oxygen concentration in mg/L. The dissolved oxygen concentration in % saturation is the ratio of the displayed concentration in mg/L to the equilibrium dissolved oxygen concentration for the sample's temperature and salinity plus ambient barometric pressure.

5.2 How to Change the Dissolved Oxygen Menu Options

To access the Dissolved Oxygen Setup menu:

1. Turn on the meter and press the **DO** key. The arrow icons that appear indicate that additional options are available within the menu.
2. Press the **SETUP** key.
3. Use the **UP ARROW** and **DOWN ARROW** keys to scroll between the desired options.

SECTION 5, continued

To set the time, date, year, or temperature units, follow the instructions in *Table 4* on page 29. *Table 11* shows how to change the other setup options.

Table 11 How to Change Dissolved Oxygen Menu Options

| Setup | How to Get There |
|--------------------------------------|--|
| Setup 5 Display Lock | From Dissolved Oxygen Reading mode, press SETUP . Press the UP ARROW until the setup number is 5. Press ENTER to toggle display lock off and on. When the desired option is selected, press EXIT to return to the reading mode. See <i>Section 5.1</i> for more information about this setup. |
| Setup 6 Measurement Resolution | From Dissolved Oxygen Reading mode, press SETUP . Press the UP ARROW until the setup number is 6. Press ENTER to toggle between 0.0 or 0.00 mg/L. When the desired option is selected, press EXIT to return to the reading mode. |
| Setup 7 Salinity Factor | Determine sample salinity. The units for salinity are parts per thousand (0/00). From Dissolved Oxygen Reading mode, press SETUP . Press the UP ARROW until the setup number is 7. Press ENTER . Use the number keys to enter a salinity factor ranging from 0 to 42. Press ENTER to accept the value, or EXIT to leave the value unchanged. When the desired value is accepted, press EXIT to return to the reading mode. See <i>Section 5.1</i> for more information about this setup. |
| Setup 8 Auto Print Interval | From Dissolved Oxygen Reading mode, press SETUP . Press the UP ARROW until the setup number is 8. Press ENTER . Change the print interval by pressing the UP ARROW and DOWN ARROW keys. Press ENTER to accept the print interval. Press the EXIT key to return to the reading mode. See <i>Section 5.1</i> for more information about this setup. |

5.3 DO Probe

5.3.1 Probe Assembly

1. Remove the membrane protector from the membrane cap.
Do not cover the small hole on the protector with your finger as you pull the protector off (*Figure 8*).
2. Hold the membrane cap in a vertical position, open-end up.
3. Fill the membrane cap about $\frac{2}{3}$ full with Dissolved Oxygen Electrolyte Filling Solution.

SECTION 5, continued

4. While holding the DO probe vertically with the tip pointing down, gently screw the module cap onto the tip. Electrolyte should leak out of the threads.

Note: If electrolyte does not leak out of the threads, air may remain inside the module cap. To ensure accurate results, repeat this procedure using more filling solution.

5. Attach the DO probe cable connector to the meter.

Figure 8 DO Probe Assembly

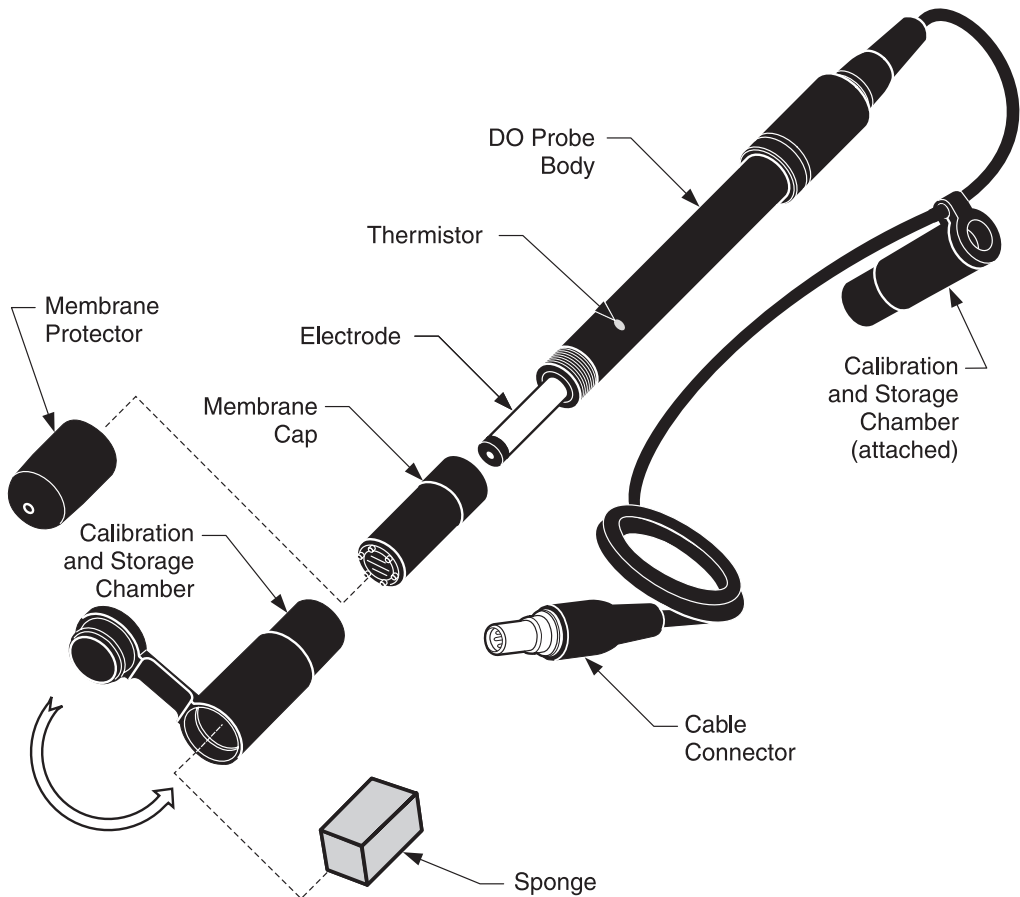

5.4 Dissolved Oxygen Calibration

The *sensio*156 Dissolved Oxygen meter must be calibrated prior to use. Prior to calibration, the probe must be prepared and stabilized. For measurements below 1 mg/L DO, the probe should be zeroed prior to calibration. See *Section 5.4.2 Zeroing the Probe*.

The calibration may be performed in three ways:

- Calibration may be performed in a water-saturated air environment. See *Section 5.4.3*.

OR

- Calibration may be performed using a water sample that has a known dissolved oxygen concentration in mg/L. The sample concentration is determined by another technique such as a Winkler titration. See *Section 5.4.4*.

OR

- Calibration may be performed by setting a water sample to 100% saturation. See *Section 5.4.5*.

5.4.1 Probe Polarization

Each dissolved oxygen probe is continuously polarized when they are connected to the instrument. A steady reading will not be seen for 30–50 minutes when the probe electrolyte is new or when the probe has been unplugged for more than one hour. Interrupted connections of less than one hour will require 5–25 minutes before a stable reading is observed.

With the probe in the calibration and storage chamber, observe the mg/L dissolved oxygen concentration after the probe has been polarized for the appropriate period of time. Calibration may be performed when the display is stable for several minutes.

SECTION 5, continued

5.4.2 Zeroing the Probe

A new DO probe can generate a 0.02 to 0.05 mg/L positive error in an oxygen-free (anoxic) solution. If this level of error is unacceptable, zero the meter with the following procedure when:

- Using a new sensing-membrane
 - Using fresh internal filling solution
 - Measuring dissolved oxygen levels less than 1 mg/L or 10% saturation
1. Measure about 150 mL of sample or deionized water into a 250-mL beaker. Add a magnetic stir bar.
 2. Add 0.25 g sodium sulfite or the contents of one Silica 3 Reagent Powder Pillow to the water. Stir to dissolve the reagent.
 3. Catalyze the reduction of dissolved oxygen by adding 0.1 mL of a 1000 mg/L Cobalt Standard solution to the water.
 4. Place the probe in the stirring sample for at least 10 minutes. This solution is good for 30 minutes or more.
 5. Press the **CAL** key. The Cal icon will appear in the upper left corner of the display, a flashing question mark will appear in the upper right corner of the display, and the **keypad** icon will appear in the lower left corner of the display. The main display will show **100%**.
 6. Press the **0** key on the keypad then press **ENTER**.
 7. The meter shows the salinity correction factor. Make sure it is set to zero and press **ENTER**.
 8. The meter shows **Stabilizing...** while readings are taken. When the meter's zero DO criteria have been met it will return to the reading mode. The meter will not exit the zeroing routine until the meter's zero criteria have been met.
 9. If the meter cannot complete the zeroing procedure it will begin to beep and show the faulty probe icon. If the meter does not complete the zeroing procedure and exit to the

SECTION 5, continued

reading mode, add additional sodium sulfite and cobalt standard solution to the anoxic solution. Otherwise, press the **EXIT** key to back up one display screen at a time and leave the calibration routine without completing the zeroing procedure.

5.4.3 Calibration in Water Saturated Air

Note: Avoid completely filling the lower part of the calibration chamber with water.

1. Secure the probe cable to the calibration and storage chamber by wrapping cable through the bottom of the chamber lid before filling with water.
2. Prepare the calibration and storage chamber by holding it under water and squeezing it a couple of times to pull a small amount of water into the lower chamber through the inlet. Alternately, open the bottom of the chamber and insert a water-soaked sponge.
3. Insert the DO probe into the calibration and storage chamber. The tip of the probe must not be flooded with water or be holding a drop of water on the membrane.
4. Allow at least ten minutes for the atmosphere in the chamber to reach a steady state.

Note: Gently squeezing the lower chamber a couple of times to force water-saturated air into the probe chamber will speed up stabilization. Avoid squeezing liquid water into the chamber.

Note: Keep the DO probe at a uniform temperature. When holding the probe, do not touch the metallic button on the side of the probe. The button is a thermistor that senses temperature. An inaccurate calibration will result if the temperature of the thermistor is different from the probe membrane.

5. Press the DO key to put the meter in DO Reading mode.
6. Press the **CAL** key located in the lower left corner of the keypad.
7. The display will show **100%**. Press the **ENTER** key. The stabilizing icon will appear while the meter completes the calibration.

SECTION 5, continued

8. When the calibration is complete, the meter will return to the reading mode. Press the **EXIT** key during the calibration sequence to back out of the calibration routine, one screen at a time, without completing a calibration.

Note: If the **Cal** and **?** icons flash after calibration, the calibration failed and needs to be repeated. See Error 6 in SECTION 8 TROUBLESHOOTING.

To obtain a printout of the calibration conditions, use the meter with the Docking station:

1. From DO Reading mode, press the **REVIEW** key.
2. Press **PRINT**.
3. Press **EXIT** to return to the reading mode.

5.4.4 Calibration to a Known Dissolved Oxygen Concentration

The *sensION156* meter can be calibrated in a water sample of known dissolved oxygen concentration. This procedure adjusts for differences between this electrode method and an alternate method such as a Winkler titration. These differences are most prevalent in samples containing high concentrations of dissolved substances.

High concentrations of dissolved substances can be corrected for by entering a sample salinity value. However, salinity values may not produce an adjustment equivalent to the value obtained by a Winkler titration because various ions affect the dissolved oxygen concentration differently.

The sample used for this calibration should be similar in temperature and atmospheric exposure to the sample used for the determination made by an alternate method.

To calibrate the meter against a dissolved oxygen concentration determined by an alternate method:

1. Place the electrode in the sample deep enough to fully cover the thermistor (metallic button) located on the side of the probe.

SECTION 5, continued

2. The sample must have a flow rate or stirring rate that allows for accurate probe performance. See *Section 5.5.2* on page 56. Make sure that no air bubbles are trapped in the sensing area of the probe tip.
3. Press the DO key to make sure the meter is in DO Reading mode.
4. Press the **CAL** key located in the lower left corner of the keypad. The Cal icon will appear in the upper left corner of the display.
5. Use the keypad to enter the concentration of the sample in mg/L. The units will automatically switch from % to mg/L.
6. The instrument will ask for a salinity correction. If the sample salinity is correct, press **ENTER**. If not, enter the value using the numeric keypad. Press the **ENTER** to accept the number. The stabilizing icon will appear while the meter completes the calibration. When the calibration is complete, the meter will return to the reading mode.
7. To end a calibration before it is completed, press the **EXIT** key during the calibration sequence to back the display screen up one at a time, then leave the calibration routine without completing a calibration.

Note: *If the Cal and ? icons flash after calibration, the calibration failed and needs to be repeated. See Error 6 in SECTION 8 TROUBLESHOOTING.*

5.4.5 Calibrating a Sample to Read 100% Saturation

The *sensio156* Dissolved Oxygen meter can be calibrated to read the dissolved oxygen in a water sample as 100% saturation. Changes in the dissolved oxygen concentration of the sample should be monitored using the % Saturation mode only, because the concentration in mg/L will not be accurate.

1. Place the electrode in the sample deep enough to fully cover the thermistor (metallic button) located on the side of the probe.

SECTION 5, continued

2. The sample must have a flow rate or stirring rate that allows for accurate probe performance. See *Section 5.5.2* on page 56. Make sure that no air bubbles are trapped in the sensing area of the probe tip.
3. Press the **CAL** key. The Cal icon will appear in the upper left corner of the display. The main display will show **100%**.
4. Press the **ENTER** key. The stabilizing icon will appear while the meter completes the calibration.
5. When the calibration is complete, the meter will return to the reading mode. Press the **EXIT** key during the calibration sequence to back out of the calibration routine, one screen at a time, without completing a calibration.

Note: *If the Cal and ? icons flash after calibration, the calibration failed and needs to be repeated. See Error 6 in SECTION 8 TROUBLESHOOTING.*

5.4.6 Calibration Review

To review the last calibration:

1. Press the **REVIEW** key on the keypad. The date and year of the last calibration will show.
2. Press the **TIME** key on the keypad to view the time of the last calibration.
3. Press the **UP ARROW**. The dissolved oxygen concentration of calibration will show.
4. Press the **DO** key to view the % saturation and mg/L values of calibration.
5. Press the **UP ARROW** key. The barometric pressure (in hPa) at the time of calibration will show. *Section 5.10* contains a unit conversions table.
6. Press the **UP ARROW** key. The salinity entry of calibration will show. Press the **PRINT** key to print a calibration report. Press the **EXIT** key to leave the calibration review.

5.5 Measuring Dissolved Oxygen

5.5.1 General Probe Operation

Follow the procedures presented below to obtain maximum performance and accuracy from your *sension156* DO system:

- Use the DO probe for aqueous applications only.
- Take extra care when handling and storing the oxygen membrane module cap.
- Do not allow the DO probe's sensing area (cap reservoir) to dry out.
- Perform the calibration procedure at the beginning of each day for maximum performance. Recalibrate the DO probe every two hours for maximum accuracy.
- The sample must have a high flow rate or must be stirred rapidly to obtain accurate results.
- Be sure any air bubbles trapped on the probe tip are dislodged before taking a reading.
- It is important to have the DO probe at a uniform temperature. Do not touch the metallic button on the side of the probe when holding it. The metallic button is a thermistor that senses sample temperature. An inaccurate measurement will result if the temperature of the thermistor is not the same as the membrane end of the probe.

5.5.2 Dissolved Oxygen Measurement

After the probe is properly stabilized, chemically zeroed (only necessary for measurements below 1 mg/L where high accuracy is required), and calibrated, take measurements as follows:

1. Add the weight assembly to the probe if required (3 or 15 m cable versions only).
2. If the sample salinity has been measured using a conductivity probe, enter the value in Setup 7. (You can also update this setup from Salinity Reading mode by pressing the up arrow. See *Section 4.6* on page 43.)

SECTION 5, continued

3. Insert the probe into the sample to the desired depth. The probe must be deep enough to cover the thermistor (metallic button) located on the side of the probe.
4. Agitate the probe in the sample to dislodge air bubbles from the sensing area of the probe tip.
5. Stir the sample vigorously with the probe or use a stir stand and stir bar. When measuring deep bodies of water, create sufficient flow across the probe tip by pulling on the cable to move the probe up and down. When using a stir stand and magnetic stir bar, increase the speed of the stir bar until the displayed value no longer increases with the stirring rate.
6. When the reading on the meter stabilizes, record or store the value in the meter memory.
7. Press the **DO %** key on the keypad to change the display from concentration in mg/L to % saturation.

Note: The displayed % saturation will be based on a meter calculation for the equilibrium dissolved oxygen concentration. The calculation uses the sample temperature, salinity, barometric pressure, and measured concentration in mg/L values. Changing the entry in Setup 7 will alter the displayed mg/L or % saturation.

5.5.3 Probe Storage

To store the probe between measurements, insert the DO probe tip into the calibration and storage chamber containing some water or a wet sponge. Keep the probe connected to the meter, if possible.

To prepare the probe for long-term storage (see *Figure 8* on page 49) complete the following steps:

1. Disconnect the probe from the meter.
2. Remove the batteries from the meter.
3. Remove the membrane cap assembly from the probe.
4. Rinse the anode, cathode, and membrane cap assembly with water.
5. Shake the water out of the membrane cap.

SECTION 5, continued

6. Use a clean lab wipe to blot the moisture from the electrode anode and cathode.
7. Thread the membrane cap assembly loosely onto the body of the probe.
8. Replace the membrane protector on the membrane cap.

5.5.4 Maintenance

Membrane cap replacement and refilling are required at scheduled intervals or whenever the membrane has been damaged or fouled. If the membrane is not damaged or fouled, the recommended time interval for replacing the electrolyte filling solution is 1–2 months.

Prior to replacing a membrane cap, rub the anode (the outer metallic stem of the probe that is visible when the membrane cap is removed) with the polishing cloth supplied with the probe. The polishing cloth will remove deposits that may decrease the performance of the probe. Polish the anode whenever the membrane cap is replaced or between membrane cap replacement, if probe performance seems to have degraded over time.

5.6 Using the BOD Accessory Kit

The optional BOD Accessory Kit, which includes an overflow funnel with a built-in stirring bar, serves three purposes:

- The kit eliminates the need to retrieve magnetic stirring bars from BOD sample bottles.
- The funnel provides an overflow reservoir to hold sample displaced when the DO probe is inserted in the bottle. This permits the measurement to be made without spilling the sample. When the DO probe is withdrawn, the displaced solution can drain back into the bottle.
- The funnel is designed to act as an electrode holder. This kit is designed for use with Hach Model 51970 DO probe only.

SECTION 5, continued

5.7 Making BOD Determinations

Use the Hach BOD Accessory Kit with a magnetic stir plate and a standard 300-mL BOD bottle.

1. Fill a standard 300-mL BOD bottle with the water sample and insert the overflow funnel.
2. Insert the DO probe into the funnel and bottle.
3. Place the BOD bottle on a magnetic stirrer so that the probe is over the center of the stir plate.
4. Start the magnetic stirrer and increase the speed until the rotor loses its cycle. Adjust until the rotor regains its cycle and mark this point on the speed scale of the stirrer. This identifies the optimum working point. Insufficient stirring will cause erroneously low readings.

Note: If air bubbles develop below or on the probe membrane, allow the stirrer about five seconds to remove them, or hold the probe at a slight angle and tap gently.

5.8 Measuring Dissolved Oxygen in Water (0 to 20 mg/L)



1. Assemble the dissolved oxygen probe as described in *Section 5.3.1* on page 48.



2. At least thirty minutes before measurement, polarize the probe by connecting it to the meter. See *Section 5.4.1* on page 50.



3. Zero the *sensioN156* Dissolved Oxygen meter if measuring DO levels less than 1 mg/L or 10% saturation.

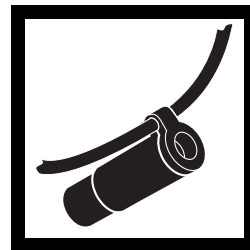

4. Secure the probe cable to the calibration and storage chamber.

SECTION 5, continued

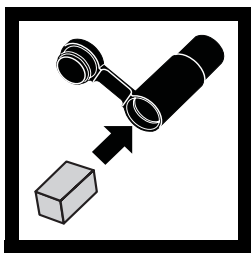

5. Prepare the calibration and storage chamber by holding it under water and squeezing it a couple of times to pull water into the lower chamber through the inlet.

Note: Avoid completely filling the lower chamber with water.

Alternately, open the bottom of the chamber and insert a water-soaked sponge.

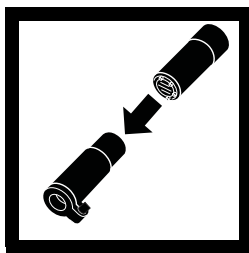

6. Insert the DO probe into the calibration and storage chamber. The probe tip must not be flooded with water or be holding a drop of water on the membrane.

Note: New sponges will be compressed. Add water to expand them.



7. Wait at least ten minutes for the atmosphere in the chamber to reach a steady state.

Note: To speed up probe stabilization, hold the probe upright and squeeze the lower chamber a couple of times to force water saturated air into the chamber. Avoid squeezing water into the chamber.

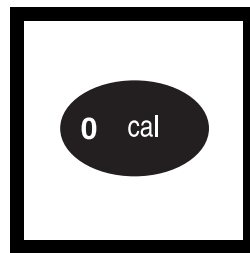

8. Press the **CAL** key. The display will show **100%**.

Note: Keep the DO probe at a uniform temperature. When holding the probe, do not touch the metallic button (temperature sensor) on the side of the probe. The calibration will be inaccurate if the temperature of the thermistor is different from the probe membrane.

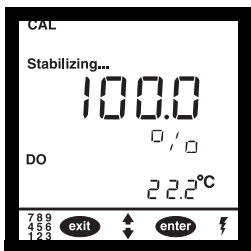

9. Press the **READ/ENTER** key. The stabilizing icon will appear while the meter completes the calibration.



10. When the calibration is complete, the meter will return to the reading mode. Press the **EXIT** key during the calibration sequence to back out of the calibration routine, one screen at a time, without completing a calibration.

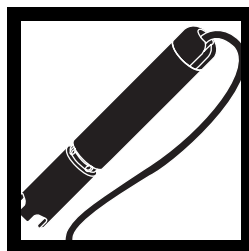

11. Add the weight assembly to the probe if required (3- or 15-m cable versions only).

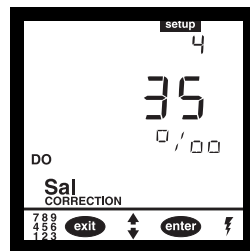

12. If necessary, enter the sample salinity value into DO Setup 7. See *Section 4.6* on page 43.

SECTION 5, continued

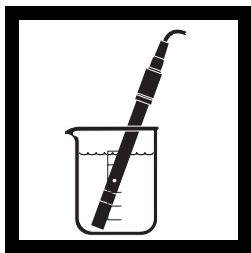

13. Insert the probe into the sample. The probe must be deep enough to cover the thermistor (metallic button) located on the side of the probe.

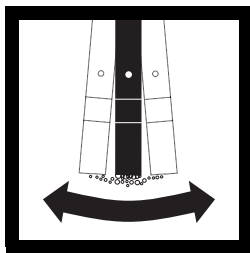

14. Agitate the probe in the sample to dislodge air bubbles from the sensing area of the probe tip.

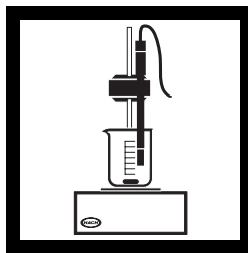

15. Stir the sample vigorously with the probe or use a stir stand and stir bar. When measuring deep bodies of water, create sufficient flow across the probe tip by pulling on the cable to move the probe up and down.



16. When the reading on the meter stabilizes, record or store the value in the meter memory.

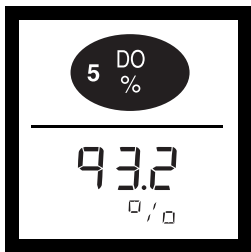

17. Press the **DO** key to change the display from concentration in mg/L to % saturation.

Note: The displayed % saturation will be based on a meter calculation for the equilibrium dissolved oxygen concentration. The calculation uses the sample temperature, salinity, barometric pressure, and measured concentration in mg/L values. Changing the entry in Setup 7 will alter the displayed mg/L or % saturation.

SECTION 5, continued

Accuracy Check

Checking Calibration Accuracy

Return the electrode to the calibration and storage chamber. The chamber should contain a wet sponge or a small amount of water. Allow at least 10 minutes for stabilization. The meter should display **100% saturation**. If not, recalibrate the meter.

Method Performance

Precision

In a single lab using one sample at 7.45 mg/L DO and one sample at 5.10 mg/L DO, the electrode was moved between the two samples with no rinsing in between. A single operator with a single sens*ion156* meter obtained a standard deviation of 0.03 mg/L DO.

Interferences

Oxidizing gases such as chlorine, chlorine dioxide, sulphur trioxide, and bromine can react at the cathode to produce positive interferences. Reducing gases such as hydrogen, hydrogen sulfide, sulfur dioxide, and boranes can react at the anode. After exposure to reducing gases, the user may need to clean the anode and replace the internal filling solution and membrane cap.

Summary of Method

The sens*ion156* Meter responds to the dissolved oxygen concentration activity by developing an electrical current. At a constant temperature, the electric current varies linearly with the oxygen concentration of the solution. An increase in temperature will increase the oxygen diffusion through the membrane exponentially. The meter utilizes automatic temperature compensation to ensure accurate results.

The following tables have been provided as a reference, but are not required for use with the DO meter.

SECTION 5, continued

5.9 Salinity Correction Factors

Use the values in *Table 12* if you do not have a conductivity probe. Use a conductivity meter to obtain conductivity in mS/cm at reference temperature (20 °C), then use *Table 12* to estimate the salinity correction factor (in ppt*) to the nearest whole number. Enter the salinity value from *Table 12* into the meter per the setup function in *Section 5.2* on page 47.

This table was calculated up to the conductivity of 54 mS/cm from the International Oceanographic Tables**.

Table 12 Salinity Correction Factors

| Conductivity in mS/cm | Salinity value* | Conductivity in mS/cm | Salinity value* | Conductivity in mS/cm | Salinity value* |
|-----------------------|-----------------|-----------------------|-----------------|-----------------------|-----------------|
| 5 | 3 | 20 | 13 | 35 | 25 |
| 6 | 4 | 21 | 14 | 36 | 25 |
| 7 | 4 | 22 | 15 | 37 | 26 |
| 8 | 5 | 23 | 15 | 38 | 27 |
| 9 | 6 | 24 | 16 | 39 | 28 |
| 10 | 6 | 25 | 17 | 40 | 29 |
| 11 | 7 | 26 | 18 | 42 | 30 |
| 12 | 8 | 27 | 18 | 44 | 32 |
| 13 | 8 | 28 | 19 | 46 | 33 |
| 14 | 9 | 29 | 20 | 48 | 35 |
| 15 | 10 | 30 | 21 | 50 | 37 |
| 16 | 10 | 31 | 22 | 52 | 38 |
| 17 | 11 | 32 | 22 | 54 | 40 |
| 18 | 12 | 33 | 23 | — | — |
| 19 | 13 | 34 | 24 | — | — |

*Salinity determined by the conductivity at 20 °C.

* ppt = Parts per Thousand of Salinity

** International Oceanographic Tables, Vol. I, National Institute of Oceanography of Great Britain, Womley, Godaming, Surrey, England and Uncesco, Paris 1971.

SECTION 5, continued

5.10 Pressure Conversions

Table 13 Pressure Conversions

| | hPa (mbar) | mm Hg | inches Hg |
|---------------------|-------------------|--------------|------------------|
| 1 hPa (mbar) | 1 | 0.75006 | 0.02953 |
| 1 mm Hg | 1.3332 | 1 | 0.039370 |
| 1 inch Hg | 33.864 | 25.400 | 1 |

Example:

To convert 1013.25 hPa to mm Hg, multiply 1013.25 by 0.75006.
The result is 760 mm Hg.

To convert 1013.25 hPa to in. Hg, multiply 1013.25 by 0.02953.
The result is 29.92 in. Hg.

6.1 Storing Measurements

The *sension*TM156 Meter can store up to 199 measurements for each parameter. Store the data and recall it later for reviewing, downloading, or printing. The following information is stored (and can be downloaded or printed) for each sample:

| pH | Conductivity | Dissolved Oxygen |
|---|---|---|
| Date | Date | Date |
| Time | Time | Time |
| Instrument serial number | Instrument serial number | Instrument serial number |
| Software version | Software version | Software version |
| An asterisk (*) on the printout indicates an unstable value was stored. | An asterisk (*) on the printout indicates an unstable value was stored. | An asterisk (*) on the printout indicates an unstable value was stored. |
| Memory location | Memory location | Memory location |
| Sample concentration in pH | Conductivity in mS or μ S | Sample concentration in mg/L |
| Sample concentration in mV | Total dissolved solids (mg/L) | Sample concentration in % saturation |
| | Salinity (per mil) ‰ | Calculated true barometric pressure |
| | Cell constant | Temperature |
| | Reference temperature | Sample salinity |
| | Temperature compensation type | |
| TDS type | | |

The new data is saved in the next available memory location, numbered from 1 to 199. If no memory locations higher than the current one are available, the meter will “wrap around” and choose the next available location. The user can also choose the storage location.

To store data:

1. After the measurement reading has stabilized, press **STORE**. The display will prompt **Store Sample #?** (# is the next available location). The question mark will be flashing.
2. Press **ENTER** to store the measurement reading in that location number. To store the data in another location, use the arrow keys to scroll to that location number or enter a

SECTION 6, continued

location using the number keys. If a data point already has data in it, you cannot scroll to it. Enter the desired location with the number keys. The meter will ask if you want to erase the current data in order to save the new data. Press **ENTER** to accept the location and store the data. Press **EXIT** to cancel.

3. If **all** memory locations are full, the meter will ask to overwrite one of the data points by displaying **Erase Sample ##?** Press **ENTER** to replace the data in that location with the current data. Press **EXIT** to return to the previous screen without replacing the data.

If the meter is full of data and you want to clear some memory, send the data to a PC or printer, (see *Section 7.2.3*), then erase the data (see *Section 6.3.2*).

4. The meter will store the reading and return to Reading mode.

6.2 Recalling Stored Data

1. To recall stored data, start in the reading mode of the parameter of interest (pH, DO, or conductivity).
2. Press the **RECALL** key. The display will show the most recently saved measurement data.
3. Use the arrow keys to scroll to the desired storage location, or press **RECALL** again to retrieve a specific data point. The question mark will flash. Enter the number of the desired memory location.
4. Press **ENTER** to accept the memory location or **EXIT** to escape.

The sections below explain details about data from each parameter.

SECTION 6, continued

6.2.1 pH Data

1. Recall pH data as described in *Section 6.2*.
2. Press the **pH/mV** key to toggle between those two forms.
3. To view the time and date of the stored value, press the **TIME** key once or twice.
4. When finished, press the **EXIT** key once or twice to return to the pH Reading mode.

6.2.2 Conductivity Data

1. Recall Conductivity data as described in *Section 6.2*.
2. Press the **CON/TDS/SAL** key to toggle between those three forms.
3. Press the **ENTER** key in succession to view the following data for each of the measurements:

Cell constant
Reference temperature
Temperature compensation type
TDS correction
4. To view the time and date of the stored value, press the **TIME** key once or twice.
5. When finished, press the **EXIT** key once or twice to return to the Conductivity Reading mode.

SECTION 6, continued

6.2.3 Dissolved Oxygen Data

1. Recall DO data as described in *Section 6.2*.
2. Press the **DO%** key to toggle between those two forms.
3. Press the **ENTER** key in succession to view the following data for each of the measurements:

Salinity Correction
Pressure
4. To view the time and date of the stored value, press the **TIME** key once or twice.
5. When finished, press the **EXIT** key once or twice to return to the DO Reading mode.

6.3 Erasing Data

6.3.1 Erasing Single Data Points

1. Recall the data that will be erased. See *Section 6.2*.
2. When the desired data point is displayed, press **ERASE**.
3. The meter will display **ERASE** and ? (flashing). Press **ENTER** to erase the data.
4. The meter will recall the next stored sample data. Select one of the three options below:
 - a. Press **ERASE** to erase the data.
 - b. Press **EXIT** to exit Recall mode.
 - c. Press an arrow key to scroll to other data points.
5. Repeat *steps 2–3* for each data point that needs to be deleted.

SECTION 6, continued

6.3.2 Erasing Multiple Data Points

1. Recall the data that will be erased. See *Section 6.2*.
2. When the point is displayed, press **ERASE**.
3. To erase all data from the current parameter press the **UP ARROW**. The instrument will show **Erase**, the current parameter type, and **All** with the flashing **?**. Select one of the three options below:
 - a. Press **EXIT** to return to the data point in Recall mode without erasing.
 - b. Press the **DOWN ARROW** to return to the single point erase prompt.
 - c. Press **ENTER** to erase all data from the current parameter. After all the data are erased, the meter will return to the Reading mode.
4. To erase all data, press the **UP ARROW** key a second time.
 - a. Press **EXIT** to return to the data point in Recall mode without erasing.
 - b. Press the **DOWN ARROW** to return to the single point erase prompt.
 - c. Press **ENTER** to erase all data. After all the data are erased, the meter will return to the Reading mode.
5. After all the data are erased, the meter will return to the Reading mode.

7.1 Connecting to Printers/Computers

7.1.1 RS232 Cable Description

The standard 9-pin RS232 connector on the Docking station connects with a 9-pin sub-D connector. A suitable cable is listed under *REPLACEMENT PARTS AND ACCESSORIES* on page 81.

The RS232 interface output is an 8-bit data word plus one stop bit and no parity with a baud rate of 1200. It can communicate with a serial printer or a serial port on a computer.

7.1.2 Connecting to a Printer

To connect a serial printer to the Docking Station, use a 9-pin to 25-pin RS232 cable. The cable provides a direct link between the instrument and the 25-pin connector used for the serial port on most serial printers. *Table 14* shows the proper pin connections for 25-pin printer cables. Using cables that do not match the pin information in the table may cause undesirable operation.

Parallel printers require a serial-to-parallel adapter. This allows use of printers that are normally used for IBM-compatible applications.

The Citizen PN60 printer requires a special printer cable that is shipped with the printer when it is ordered from Hach Company.

Table 14 Standard 9-pin to 25-pin Printer Cable

| 9-pin D Connector Socket | | Serial Printer 25-pin D Connector, Plug | |
|--------------------------|-------------|---|-------------|
| Pin | Signal Name | Pin | Signal Name |
| 2 | RXD | no connection | |
| 3 | TXD | 3 | RXD |
| 4 | DTR | no connection | |
| 5 | GND | 7 | GND |
| 6 | DSR | 20 | DTR |
| 7 | RTS | no connection | |
| 8 | CTS | 20 | DTR |

1. Align the holes in the RS232 cable connector with the pins in the serial port of the Docking Station.

SECTION 7, continued

2. Gently and firmly push the cable into the Docking Station.
3. Tighten the screws on each side of the cable connector (see *Figure 9*). Connect the cable to the printer in the same manner.
4. Once the communication link is established, press **PRINT** to send data to the printer.

Note: For optimum performance and ESD protection, use a five-conductor shielded cable. Use a metal shell for the printer or computer terminal connector, and connect the shield of the cable to the metal shell and the sleeve (signal ground) of the RS232 plug.

Follow the manufacturers instructions to configure the printer for compatibility with the meter.

Figure 9 RS232 Cable Connector

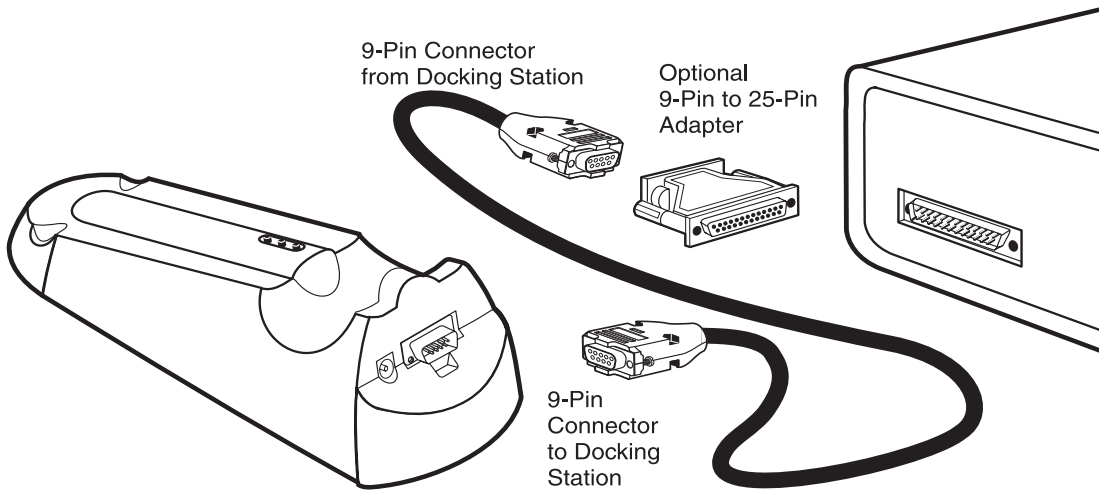

SECTION 7, continued

7.1.3 Connecting to a Personal Computer

Connect the Docking Station to a personal computer (PC) with the computer interface cable (Cat. No. 48129-00) listed under *REPLACEMENT PARTS AND ACCESSORIES* on page 81. The cable directly links the meter and the 9-pin D connector used for the serial port on most personal computers. If your computer has a 25-pin D connector, use a 9-pin to 25-pin adapter (available at most computer supply stores).

Table 15 Standard 9-pin to 9-pin Computer Cable

| 9-pin D Connector Socket | | Computer 9-pin D Connector, plug | |
|--------------------------|-------------|----------------------------------|-------------|
| Pin | Signal Name | Pin | Signal Name |
| 2 | RXD | 3 | TXD |
| 3 | TXD | 2 | RXD |
| 4 | DTR | no connection | --- |
| 5 | GND | 5 | GND |
| 6 | DSR | no connection | --- |
| 7 | RTS | 8 | CTS |
| 8 | CTS | 7 | RTS |

Table 15 shows the proper pin connections for 9-pin computer cables. Using cables that do not match the pin information in the table may cause undesirable operation.

1. Align the holes in the RS232 cable connector with the pins in the serial port of the Docking Station.
2. Gently and firmly push the cable into the Docking Station.
3. Tighten the screws on each side of the cable connector (see *Figure 9*). Connect the cable to the computer in the same manner.
4. Once the communication link is established, press **PRINT** to send data to the computer.

To transfer data, the communication parameters (baud rate, data bits and parity) of the meter and the computer must match. Once the communication link is established, press **PRINT** to send data to the computer.

SECTION 7, continued

7.1.4 Using HachLink™ Communications Software with a PC

HachLink (Cat. No. 49665-00) software allows a personal computer to capture data from *sensio*™ electrochemical meters. Users can store the captured data in a text file, a spreadsheet compatible format (i.e., Excel, Microsoft Works, Lotus 123), or unformatted text.

A personal computer running HachLink must meet the following minimum requirements:

- Pentium recommended, 486 minimum required
- 16 megabytes of RAM
- Hard disk drive with 4 megabytes or more of free space
- 3½ inch, 1.44 megabyte floppy disk drive, or CD-ROM drive
- Video card capable of 256 colors at 800 x 600 resolution
- Mouse or other pointing device
- A 9-pin serial port (or 25-pin serial port with 9-pin adapter) or port expansion board
- Windows 95, 98, 2000, or NT or later

7.2 Sending Data to Printers/Computers

7.2.1 Sending Currently Displayed Data

To print or transfer a current reading:

1. Wait until the display is stable. Press **PRINT**.
2. The word **PRINT** will briefly appear, then the meter will return to the reading mode.

The printout for data that is not stored will not have a storage location number.

7.2.2 Sending Recalled Data Points

1. Recall data by following the steps in *Section 6.2* on page 66.
2. When the desired sample data is displayed, press **PRINT**.

SECTION 7, continued

3. The words **PRINT** and **Sample**, the sample number, and a flashing ? will be displayed.
4. Press **ENTER** to print the recalled data point.
5. Press **EXIT** to return to the reading mode.

7.2.3 Sending Multiple Data Points

1. Recall a data point. See *Section 6.2* on page 66.
2. When a data point appears, press **PRINT**.
3. To send all data from the current parameter, press the **UP ARROW**. The instrument will show **Print**, the current parameter type, and **All** with the ? (flashing). Select one of the three options below:
 - a. To return to the next data point in Recall mode without printing, press **EXIT**.
 - b. To return to the prompt for printing single data points, press the **DOWN ARROW**.
 - c. To print all stored data from the current parameter, press **ENTER**. The word **PRINT** will appear until all the data has been printed. Then the meter will return to the first recalled sample. Press **EXIT** to return to the reading mode or an arrow key to scroll to a specific data point.
4. To send all data, press the press the **UP ARROW** key again.
 - a. To return to the next data point in Recall mode without printing, press **EXIT**.
 - b. To return to the prompt for printing all the data from the current parameter, press the **DOWN ARROW**.
 - c. To print **all** stored data, press **ENTER**. The word **PRINT** will appear until all the data has been printed. Then the meter will return to the first recalled sample. Press **EXIT** to return to the reading mode or an arrow key to scroll to a specific data point.

SECTION 7, continued

7.3 Printed Data Formats

7.3.1 pH Printed Data Format

| Storage Location | Reading | Temperature | mV Reading | Date | Time | Meter Model | Serial Number | Software Version |
|------------------|---------|-------------|------------|----------|-------|-------------|---------------|------------------|
| # 1 | 7.53 pH | 22.7 C | -30.0 mV | 10/03/98 | 08:30 | senslon156 | 12344577 | PX.X |
| # 2 | 6.13 pH | 13.6 C | 50.0 mV | 10/04/98 | 09:11 | senslon156 | 12344577 | PX.X. |
| # 3 | 7.01 pH | 20.1 C | -0.0 mV | 10/10/98 | 12:44 | senslon156 | 12344577 | PX.X |

7.3.2 Conductivity Printed Data Format

| | TDS, Salinity or Conductivity Reading† | Units | Sample Temperature | Alternate Units | Reference Temperature/ Temperature compensation | Date | Time | Serial Number | Software Version |
|---|--|-------|--------------------|-----------------|---|----------|-------|---------------|------------------|
| 1 | 400 | µS/cm | 13.5 °C | 0.450/cm | Tref:25 Tc:0.0% | 10/03/99 | 08:30 | SI512344577 | FX.X |
| 2 | 557 | mg/L | 13.5 °C | TDS:NaCl | | 10/04/99 | 09:11 | SI512344577 | FX.X |
| 3 | 0.6 | ‰ | 13.5 °C | 881 µS/cm | | 10/10/99 | 12:44 | SI512344577 | FX.X |
| 4 | 1284 | µS/cm | 25.0 °C | 0.450/cm | Tref:20 Tc:2.00% | 10/12/99 | 23:10 | SI512344577 | FX.X |
| 5 | 642 | mg/L | 25.0 °C | TDS:0.500 | Tref:20 Tc:2.00% | 10/13/99 | 13:45 | SI512344577 | FX.X |
| 6 | 1412 | µS/cm | 25.0 °C | 0.450/cm | Tref:25 Tc:NaCl | 10/13/99 | 14:23 | SI512344577 | FX.X |

† Value depends on the mode used to measure the sample. For example, the TDS value will appear in this column if the meter was in TDS mode during the stored measurement. Look at the units column to determine the parameter. Conductivity measurements are shown with units of mS/cm or µS/cm. Salinity is shown with units of parts per thousand (‰). TDS is shown with units of mg/L.

Tref:= reference temperature in °C; Tc:= temperature compensation in effect;
 TDS:= TDS calculation scheme in effect; 0.450/cm is the cell constant;
 881 µS/cm is the non-temperature corrected conductivity for stored salinity

7.3.3 Dissolved Oxygen Printed Data Format

| Storage Location | Concentration | % Saturation | Calculated True Barometric Pressure | Temp. | Salinity | Date | Time | Serial Number | Software Version |
|------------------|---------------|--------------|-------------------------------------|---------|----------|----------|-------|---------------|------------------|
| # 1 | 7.42 mg/L | 100.3 | 25.0 inHg | 69.8 °F | o/oo | 01/09/00 | 01:42 | 600010 | P1.03 |
| # 2 | 7.42 mg/L | 100.2 | 25.0 inHg | 69.8 °F | o/oo | 01/09/00 | 01:42 | 600010 | P1.03 |
| # 3 | 7.42 mg/L | 100.2 | 25.0 inHg | 69.8 °F | o/oo | 01/09/00 | 01:42 | 600010 | P1.03 |

8.1 Error Codes

Error codes inform the user of an out-of-range value or meter problem. *Table 16* outlines the operator assistance codes available in the meter series.

Table 16 Error Codes

| Error Code | Meaning | Possible Remedy |
|------------|---|---|
| 1 | Unconfigured instrument (no data in EEPROM) | Call or return to Hach service. |
| 2 | pH calibration error (latest point produced invalid slope)—probably read the wrong buffer, could also indicate an electrode failure. | Verify you have the correct buffer and reread. |
| 3 | Reading stabilized at a pH in between valid buffers, possibly caused by reading the wrong buffer, or electrode failure. | Verify you have the correct buffer and reread. |
| 4 | Could not write stored data to EEPROM | Call or return to Hach service. |
| 5 | Conductivity calibration error—Probably read the wrong conductivity buffer, or electrode failure. | Verify you have the correct buffer and reread. |
| 6 | DO calibration error—Probably caused by calibrating with an unpolarized electrode or using the wrong calibration standard. | Wait at least 20–30 minutes longer or use the correct standard and redo the DO calibration. |
| 7 | Measurement overrange error—The parameter measurement cannot be calculated correctly pH/mV outside of ± 2000 mV range | pH electrode may be out of solution, or broken. |
| | DO concentration > 30 mg/L | DO electrode may need more time to polarize after attaching to the meter. |
| | Conductivity—either Raw (uncompensated) conductivity or displayed conductivity > 256 mS/cm or Salinity > 43 or TDS > 50 g/L. | Conductivity electrode may require a diluted sample to read correctly, or may need calibrating. |
| 8 | Temperature out of range (DO or Salinity) The DO and Salinity measurement calculations are only valid within the specified temperature ranges. | Change the temperature of the sample. |
| 9–13 | NA | Call or return to Hach service. |

8.2 Meter Service Request Questionnaire

1. What is the complete lot code of the meter and electrode?
2. On what date was the meter purchased?
3. How long has the meter been in use?
4. What types of samples are being tested?
5. What is the temperature of the samples being tested?
6. How often is the meter being used?
7. How is the electrode stored between uses?
8. If the meter has been in use for a while, what maintenance has been performed?
9. Describe the suspected problem or failure of the meter.
10. Please have your meter, electrode, buffers/standards, and this completed questionnaire near the phone before calling technical support.



GENERAL INFORMATION

At Hach Company, customer service is an important part of every product we make.

With that in mind, we have compiled the following information for your convenience.

REPLACEMENT PARTS AND ACCESSORIES

ACCESSORIES

| Description | Quantity Required | | Cat. No. |
|---|-------------------|------|----------|
| | Per Test | Unit | |
| Batteries, AA..... | 4 | /pkg | 19380-04 |
| Docking Station, external, 115 V, N. American style plug..... | each | | 51875-01 |
| Docking Station, external, 230 V, European style plug..... | each | | 51875-02 |
| Electrode Stand..... | each | | 45300-00 |
| Electrode Stand with Electromagnetic Stirrer, 115 V ac..... | each | | 45300-01 |
| Electrode Stand with Electromagnetic Stirrer, 230 V ac..... | each | | 45300-02 |
| Print Cartridges for PN60, black..... | 2 | /pkg | 26690-00 |
| Printer, Citizen PN60I, 115 V, North American plug..... | each | | 26687-00 |
| Printer Interface Cable, 9-pin to 25-pin..... | each | | 49503-00 |
| Printer Port Cable for PN60..... | each | | 26689-00 |
| Power Cord, European style for Citizen PN60I printer..... | each | | 46836-00 |
| Software, HachLink™, 3½ in. Disk..... | each | | 49665-00 |

REQUIRED REAGENTS, pH

Buffer, Powder Pillows

| | | | |
|----------------------------------|---|--------|----------|
| pH 4.01, color-coded red..... | 1 | 15/pkg | 22269-95 |
| pH 7.00, color-coded yellow..... | 1 | 15/pkg | 22270-95 |
| pH 10.00, color-coded blue..... | 1 | 15/pkg | 22271-95 |

Buffer Solutions

| | | | |
|--|-------|--------|----------|
| pH 4.01, color-coded red..... | 20 mL | 500 mL | 22834-49 |
| pH 7.00, color-coded yellow..... | 20 mL | 500 mL | 22835-49 |
| pH 10.01, color-coded blue..... | 20 mL | 500 mL | 22836-49 |
| pH Electrode Storage Powder Pillows..... | 20 | /pkg | 26573-64 |
| pH Electrode Storage Solution..... | 475 | mL | 50301-49 |

Singlets:

| | | | |
|--|----|----------|----------|
| pH Singlet, pH 4 and 7 buffer solutions..... | 10 | each/pkg | 27699-20 |
| pH Singlet, pH 4 buffer solution..... | 20 | /pkg | 27700-20 |
| pH Singlet, pH 7 buffer solution..... | 20 | /pkg | 27701-20 |
| pH Singlet, pH 10 buffer solution..... | 20 | /pkg | 27702-20 |
| Rinse Singlet, electrode rinse solution..... | 20 | /pkg | 27703-20 |

OPTIONAL APPARATUS, pH

| | | | |
|---|------|--|----------|
| Beaker, poly, 50 mL..... | each | | 1080-41 |
| Demineralizer Bottle, 177 mL..... | each | | 14299-00 |
| Electrode, pH, gel-filled, w/temp, 5-pin connector..... | each | | 51935-00 |
| Electrode, pH combination, flat end, 5-pin..... | each | | 51915-00 |

REPLACEMENT PARTS AND ACCESSORIES, continued

OPTIONAL APPARATUS, pH, continued

| Description | Quantity Required | | Cat. No. |
|--------------------------------|-------------------|-------|----------|
| | Per Test | Unit | |
| Electrode Washer | each | | 27047-00 |
| Temperature Probe, 5-pin | each | | 51980-00 |

OPTIONAL APPARATUS, pH, continued

| | | | |
|---------------------------------------|------|-------|----------|
| Stir Bar, $7/16 \times 3/16$ in. | each | | 45315-00 |
|---------------------------------------|------|-------|----------|

REQUIRED REAGENTS, CONDUCTIVITY

| | | | |
|--|--------|-------|----------|
| TDS Singlet, 180 $\mu\text{S}/\text{cm}$ conductivity standard..... | 20/pkg | | 27704-20 |
| TDS Singlet, 1000 $\mu\text{S}/\text{cm}$ conductivity standard..... | 20/pkg | | 27705-20 |
| TDS Singlet, 1990 $\mu\text{S}/\text{cm}$ conductivity standard..... | 20/pkg | | 27706-20 |
| TDS Singlet, 18,000 $\mu\text{S}/\text{cm}$ conductivity standard..... | 20/pkg | | 27707-20 |
| TDS Singlet, 53 mS/cm conductivity standard..... | 20/pkg | | 27708-20 |

OPTIONAL REAGENTS, CONDUCTIVITY

| | | | |
|---|------------|-------|----------|
| Gallic Acid Solution | 50 mL SCDB | | 14423-26 |
| Phenolphthalein Indicator Solution | 15 mL SCDB | | 162-36 |
| Potassium Chloride, ACS | 454 g | | 764-01 |
| Sodium Chloride Standard Solution, 1000 mg/L (1990 ± 20 $\mu\text{S}/\text{cm}$, 995 ± 5 TDS) | 100 mL | | 2105-42 |
| Sodium Chloride Standard Solution, 85.47 mg/L (180 ± 10 $\mu\text{S}/\text{cm}$, 90 ± 5 TDS) | 100 mL | | 23075-42 |
| Sodium Chloride Standard Solution, 491 mg/L (1000 ± 10 $\mu\text{S}/\text{cm}$, 500 ± 5 TDS) | 100 mL | | 14400-42 |
| Sodium Chloride Standard Solution, 10246 mg/L (18000 ± 50 $\mu\text{S}/\text{cm}$, 9000 ± 25 TDS) | 100 mL | | 23074-42 |
| Potassium Chloride Standard Solution, 53000 $\mu\text{S}/\text{cm}$, 35 ppt salinity | 500 mL | | 27143-49 |

OPTIONAL APPARATUS, CONDUCTIVITY

| | | | |
|---|-------|-------|----------|
| Beaker, poly, 50 mL..... | each | | 1080-41 |
| Batteries, AA, Alkaline..... | 4/pkg | | 19380-04 |
| Bottle, wash, 125 mL | each | | 620-14 |
| Computer Interface Cable, 9-pin to 9-pin..... | each | | 48129-00 |
| Low Ionic Strength Chamber..... | each | | 51899-00 |
| Probe, Conductivity, 1 m cable | each | | 51975-00 |
| Probe, Conductivity, 3 m cable | each | | 51975-03 |

REPLACEMENT PARTS AND ACCESSORIES, continued

OPTIONAL REAGENTS, DISSOLVED OXYGEN

| Description | Quantity Required | | Cat. No. |
|--|-------------------|-----------|----------|
| | Per Test | Unit | |
| Cobalt Standard Solution, 1000 mg/L..... | 100 | mL..... | 21503-42 |
| Filling Solution, Dissolved Oxygen..... | 50 | mL..... | 27591-26 |
| Silica 3 Reagent Powder Pillows (contains sodium sulfite)..... | 100 | /pkg..... | 271-69 |
| Sodium Sulfite..... | 454 | g..... | 195-01 |

OPTIONAL APPARATUS, DISSOLVED OXYGEN

| | | |
|--|-------------|----------|
| Barometer, Digital..... | each..... | 27584-00 |
| BOD Accessory Kit | | |
| Includes funnel and spacer for Dissolved Oxygen Probe..... | each..... | 51971-00 |
| Dissolved Oxygen Probe Cable, 1 meter..... | each..... | 51970-00 |
| Dissolved Oxygen Probe Cable, 3 meter..... | each..... | 51970-03 |
| Dissolved Oxygen Probe Cable, 15 meter..... | each..... | 51970-15 |
| Calibration Storage Chamber, Dissolved Oxygen Probe..... | each..... | 51974-00 |
| Cobalt Standard Solution, 100 mg/L..... | 100 mL..... | 21503-42 |
| Dissolved Oxygen Service Kit | | |
| Includes 2 membranes, fill solution, polishing cloth, 2 sponges..... | each..... | 51968-00 |
| Membranes, for Dissolved Oxygen Probe..... | 2/pkg..... | 51973-00 |
| Weight Assembly..... | each..... | 51969-00 |

HOW TO ORDER

By Telephone:

6:30 a.m. to 5:00 p.m. MST
Monday through Friday
(800) 227-HACH
(800-227-4224)

By FAX: (970) 669-2932

By Mail:

Hach Company
P.O. Box 389
Loveland, CO 80539-0389
U.S.A.

Ordering information by E-mail: orders@hach.com

Information Required

- Hach account number (if available)
- Your name and phone number
- Purchase order number
- Brief description or model number
- Billing address
- Shipping address
- Catalog number
- Quantity

Technical and Customer Service (U.S.A. only)

Hach Technical and Customer Service Department personnel are eager to answer questions about our products and their use. Specialists in analytical methods, they are happy to put their talents to work for you.

Call **1-800-227-4224** or E-mail techhelp@hach.com.

International Customers

Hach maintains a worldwide network of dealers and distributors. To locate the representative nearest you, send E-mail to intl@hach.com or contact:

In Canada, Latin America, Africa, Asia, Pacific Rim:

Telephone: (970) 669-3050; FAX: (970) 669-2932

In Europe, the Middle East, or Mediterranean Africa:

HACH Company, c/o

Dr. Bruno Lange GmbH

Willstätterstr. 11

D-40549 Düsseldorf

Germany

Telephone: +49/[0]211.52.88.0

Fax: +49/[0]211.52.88.231

REPAIR SERVICE

Authorization must be obtained from Hach Company before sending any items for repair. Please contact the HACH Service Center serving your location.

In the United States:

Hach Company
100 Dayton Avenue
Ames, Iowa 50010
(800) 227-4224 (U.S.A. only)
Telephone: (515) 232-2533
FAX: (515) 232-1276

In Canada:

Hach Sales & Service Canada Ltd.
1313 Border Street, Unit 34
Winnipeg, Manitoba
R3H 0X4
(800) 665-7635 (Canada only)
Telephone: (204) 632-5598
FAX: (204) 694-5134
E-mail: canada@hach.com

In Latin America, the Caribbean, the Far East, the Indian Subcontinent, Africa, Europe, or the Middle East:

Hach Company World Headquarters
P.O. Box 389
Loveland, Colorado, 80539-0389
U.S.A.
Telephone: (970) 669-3050
FAX: (970) 669-2932
E-mail: intl@hach.com

WARRANTY

Hach warrants most products against defective materials or workmanship for at least one year from the date of shipment; longer warranties may apply to some items.

HACH WARRANTS TO THE ORIGINAL BUYER THAT HACH PRODUCTS WILL CONFORM TO ANY EXPRESS WRITTEN WARRANTY GIVEN BY HACH TO THE BUYER. EXCEPT AS EXPRESSLY SET FORTH IN THE PRECEDING SENTENCE, HACH MAKES NO WARRANTY OF ANY KIND WHATSOEVER WITH RESPECT TO ANY PRODUCTS. HACH EXPRESSLY DISCLAIMS ANY WARRANTIES IMPLIED BY LAW, INCLUDING BUT NOT BINDING TO ANY WARRANTY OF MERCHANTABILITY OR FITNESS FOR A PARTICULAR PURPOSE.

LIMITATION OF REMEDIES: Hach shall, at its option, replace or repair nonconforming products or refund all amounts paid by the buyer. **THIS IS THE EXCLUSIVE REMEDY FOR ANY BREACH OF WARRANTY.**

LIMITATION OF DAMAGES: IN NO EVENT SHALL HACH BE LIABLE FOR ANY INCIDENTAL OR CONSEQUENTIAL DAMAGES OF ANY KIND FOR BREACH OF ANY WARRANTY, NEGLIGENCE, ON THE BASIS OF STRICT LIABILITY, OR OTHERWISE.

This warranty applies only to Hach products purchased and delivered in the United States.

Catalog descriptions, pictures and specification, although accurate to the best of our knowledge, are not a guarantee or warranty.

For a complete description of Hach Company's warranty policy, request a copy of our Terms and Conditions of Sale for U.S. Sales from our Customer Service Department.

Hach warrants the meter against defective materials or workmanship for three years from the date of shipment. The Docking Station has a warranty of one year from the date of shipment.

CERTIFICATION

Hach Company certifies this instrument was tested thoroughly, inspected and found to meet its published specifications when it was shipped from the factory.

The *sensioN156*TM Multiparameter Meter has been tested and is certified as indicated to the following instrumentation standards:

Product Safety

External Power Supplies Only:

115 V ac Supply, UL Listed & CSA Certified or

230 V ac Supply, CE Marked per 73/23/EEC, VDE Listed

EMI Immunity

Instrument Tested with the external 230V, 50 Hz Power Supply:

Per **89/336/EEC** EMC: **EN 61326:1998** (Electrical Equipment for measurement, control and laboratory use- EMC requirements) Supporting test records by Hach Company, certified compliance by Hach Company.

Standards Include

IEC 1000-4-2:1995 (EN 61000-4-2:1995) Electrostatic Discharge Immunity (Criteria B)

IEC 1000-4-3:1995 (EN 61000-4-3:1996) Radiated RF Electromagnetic Field Immunity (Criteria B)

IEC 1000-4-4:1995 (EN 61000-4-4:1995) Electrical Fast Transients/Burst (Criteria B)

IEC 1000-4-5:1995 (EN 61000-4-5:1995) Surge (Criteria B)

IEC 1000-4-6:1996 (EN 61000-4-6:1996) Conducted Disturbances Induced by RF Fields (Criteria A)

IEC 1000-4-11:1994 (EN 61000-4-11:1994) Voltage Dip/Short Interruptions (Criteria B)

CERTIFICATION, continued

Additional immunity Standard/s include:

ENV 50204:1996 Radiated Electromagnetic Field from Digital Telephones (Criteria A)

Emissions

Instrument Tested with the external 230V, 50 Hz Power Supply:

Per **89/336/EEC EMC: EN 61326:1998** (Electrical Equipment for measurement, control and laboratory use-EMC requirements) Class “B” emission limits. Supporting test records by Hewlett Packard, Fort Collins, Colorado Hardware Test Center (A2LA # 0905-01), certified compliance by Hach Company.

Standards include:

EN 61000-3-2 Harmonic Disturbances Caused by Electrical Equipment

EN 61000-3-3 Voltage Fluctuation (Flicker) Disturbances Caused by Electrical Equipment

Additional Emissions Standard/s Include

EN 55011 (CISPR 11), Class “B” emission limits

CANADIAN INTERFERENCE-CAUSING EQUIPMENT REGULATION, IECS-003: Class “A” emission limits.

Supporting test records by Hewlett Packard, Fort Collins, Colorado Hardware Test Center (A2LA # 0905-01), certified compliance by Hach Company.

This Class A digital apparatus meets all requirements of the Canadian Interference- Causing Equipment Regulations.

Cet appareil numérique de la classe A respecte toutes les exigences du Règlement sur le matériel brouilleur du Canada.

FCC PART 15: Class emission “A” limits. Supporting test records by Hewlett Packard, Fort Collins, Colorado Hardware Test Center (A2LA # 0905-01), certified compliance by Hach Company.

This device complies with Part 15 of the FCC Rules. Operation is subject to the following two conditions:

CERTIFICATION, continued

(1) this device may not cause harmful interference, and (2) this device must accept any interference received, including interference that may cause undesired operation.

Changes or modifications to this unit not expressly approved by the party responsible for compliance could void the user's authority to operate the equipment.

This equipment has been tested and found to comply with the limits for a Class A digital device, pursuant to Part 15 of the FCC Rules. These limits are designed to provide reasonable protection against harmful interference when the equipment is operated in a commercial environment. This equipment generates, uses, and can radiate radio frequency energy and, if not installed and used in accordance with the instruction manual, may cause harmful interference to radio communications. Operation of this equipment in a residential area is likely to cause harmful interference, in which case the user will be required to correct the interference at his own expense. The following techniques of reducing the interference problems are applied easily.

1. Disconnect the external power supply from the *sensio156* Multiparameter Meter to verify that the meter is or is not the source of the interference.
2. Move the *sensio156* Multiparameter Meter and its power supply away from the device receiving the interference.
3. Reposition the receiving antenna for the device receiving the interference.
4. Try combinations of the above.



HACH COMPANY
WORLD HEADQUARTERS
P.O. Box 389
Loveland, Colorado 80539-0389
Telephone: (970) 669-3050
FAX: (970) 669-2932

FOR TECHNICAL ASSISTANCE, PRICE INFORMATION AND ORDERING:

In the U.S.A. - **Call toll-free 800-227-4224**

Outside the U.S.A. - **Contact the HACH office or distributor serving you.**

On the Worldwide Web - **www.hach.com; E-mail - techhelp@hach.com**
